



# **User's Guide**

## **Multimedia Projector**



**EB-G5750WU**

**EB-G5450WU**





## Notations Used in This Guide

- **Safety indications**

The documentation and the projector use graphical symbols to show how to use the projector safely. Please understand and respect these caution symbols in order to avoid injury to persons or property.

 <b>Warning</b>	This symbol indicates information that, if ignored, could possibly result in personal injury or even death due to incorrect handling.
 <b>Caution</b>	This symbol indicates information that, if ignored, could possibly result in personal injury or physical damage due to incorrect handling.

- **General information indications**

<b>Attention</b>	Indicates procedures which may result in damage or injury if sufficient care is not taken.
	Indicates additional information and points which may be useful to know regarding a topic.
	Indicates a page where detailed information regarding a topic can be found.
	Indicates that an explanation of the underlined word or words in front of this symbol appears in the glossary of terms. See the "Glossary" section of the "Appendix".  <a href="#">p.150</a>
<div style="border: 1px solid black; padding: 2px; display: inline-block;"><b>Procedure</b></div>	Indicates operating methods and the order of operations. The procedure indicated should be carried out in the order of the numbered steps.
[(Name)]	Indicates the name of the buttons on the Remote Control or the Control panel. Example: [Esc] button
"(Menu Name)" <b>Brightness (Boldface)</b>	Indicates the configuration menu items. Example: <b>Select "Brightness" from the Image menu.</b> <b>Image menu - Brightness</b>

## Notations Used in This Guide ..... 2

### Introduction

---

#### Projector Features ..... 8

Ease of Use when Installed on a Ceiling Mount	8
Reliability You can Depend on	8
Meets a Wide Range of Needs	8
Enhanced Security Functions	9
Easy to Handle	9
Monitoring and Control Functions	9
Taking Full Advantage of a Network Connection	9

#### Part Names and Functions ..... 10

Front/Top	10
Base	11
Rear	11
Interface	12
Control Panel	13
Remote Control	14
Installing the batteries	15
Operating range of remote control	17

### Useful Functions

---

#### Adjusting the Projected Image ..... 19

Displaying a Test Pattern	19
Adjusting the Position of the Projected Image (Lens Shift)	20
Correcting Distortion in the Projected Image	20
Quick Corner	21
H/V-Keystone	23

#### Changing the Projected Image ..... 25

Automatically Detect Input Signal and Change the Projected Image (Source Search)	25
--	----

Switch to the Target Image by Remote Control	26
--	----

#### Changing the Aspect Ratio of the Projected Image ..... 27

Changing the Aspect Mode	27
Projecting images from video equipment or from the HDMI input port	27
Projecting images from a computer	28

#### Selecting the Projection Quality (Selecting Color Mode) ..... 29

#### Projecting Two Images Simultaneously (Split Screen) ..... 30

Input Sources for Split Screen Projection	30
Operating Procedures	30
Projecting on a split screen	30
Switching the left and right screens	31
Switching the left and right image sizes	31
Ending the split screen	32
Restrictions during Split Screen Projection	32
Operating restrictions	32
Restriction relating to images	33

#### Functions for Enhancing Projection ..... 34

Hiding the Image and Sound Temporarily (A/V Mute)	34
Freezing the Image (Freeze)	34
Pointer Function (Pointer)	35
Enlarging Part of the Image (E-Zoom)	36

#### Limitation of the Number of the Target Projectors when Using Multiple Projectors ..... 38

Setting the Projector ID	38
Checking the Projector ID	38
Setting the Remote Control ID	39

#### Color Correction when Projecting from Multiple Projectors (Multi-screen Color Adjustment) ..... 41

Summary of Correction Procedure	41
Correction Method	41

#### Saving a User's Logo ..... 43

#### Security Functions ..... 45

Managing Users (Password Protect) . . . . .	45
Type of Password Protect . . . . .	45
Setting Password Protect . . . . .	45
Entering the Password . . . . .	46
Restricting Operation (Control Panel Lock) . . . . .	47
Anti-Theft Lock . . . . .	48
Installing the wire lock . . . . .	48
Anti-theft projection lens . . . . .	48

## Configuration Menu

<b>Using the Configuration Menu . . . . .</b>	<b>50</b>
<b>Image Menu . . . . .</b>	<b>51</b>
<b>Signal Menu . . . . .</b>	<b>53</b>
<b>Settings Menu . . . . .</b>	<b>55</b>
<b>Extended Menu . . . . .</b>	<b>57</b>
<b>Network Menu . . . . .</b>	<b>60</b>
Notes on Operating the Network Menu . . . . .	61
Soft Keyboard Operations . . . . .	61
Basic Menu . . . . .	62
Wireless LAN Menu . . . . .	63
Security Menu (Only available when the Wireless LAN unit is installed) . . . . .	65
When WEP is selected . . . . .	66
When WPA-PSK(TKIP/AES) or WPA2-PSK(TKIP/AES) is selected . . . . .	68
When EAP-TLS is selected . . . . .	69
EAP-TTLS/MD5, EAP-TTLS/MS-CHAPv2, PEAP/MS-CHAPv2, PEAP/GTC, LEAP, EAP-Fast/MS-CHAPv2, EAP-Fast/GTC is selected . . . . .	70
Wired LAN Menu . . . . .	71
Mail Menu . . . . .	72
Others Menu . . . . .	73
Reset Menu . . . . .	74

<b>Info Menu (Display Only) . . . . .</b>	<b>75</b>
---	-----------

<b>Reset Menu . . . . .</b>	<b>76</b>
-----------------------------	-----------

## Troubleshooting

<b>Using the Help . . . . .</b>	<b>78</b>
---------------------------------	-----------

<b>Problem Solving . . . . .</b>	<b>80</b>
----------------------------------	-----------

Reading the Indicators . . . . .	80
Indicator is lit or flashing red . . . . .	81
Indicator is flashing or lit . . . . .	82
When the Indicators Provide No Help . . . . .	84
Problems relating to images . . . . .	85
Problems when projection starts . . . . .	89
Other problems . . . . .	90
Interpreting Event IDs . . . . .	92

## Maintenance

<b>Cleaning . . . . .</b>	<b>94</b>
---------------------------	-----------

Cleaning the Projector's Surface . . . . .	94
Cleaning the Lens . . . . .	94
Cleaning the Air Filter . . . . .	94

<b>Replacing Consumables . . . . .</b>	<b>97</b>
--	-----------

Replacing the Lamp . . . . .	97
Lamp replacement period . . . . .	97
How to replace the lamp . . . . .	97
Resetting the Lamp Hours . . . . .	100
Replacing the Air Filter . . . . .	100
Air filter replacement period . . . . .	100
How to replace the air filter . . . . .	100

<b>Notes on Transportation . . . . .</b>	<b>102</b>
--	------------

Moving Nearby . . . . .	102
-------------------------	-----

When Transporting .....	102
Preparing packaging .....	102
Notes when packing and transporting .....	102

## Monitoring and Controls

<b>EasyMP Monitor .....</b>	<b>104</b>
<b>Changing Settings Using a Web Browser (Web Control) .....</b>	<b>105</b>
Displaying Web Control .....	105
Displaying Web Remote .....	105
<b>Using the Mail Notification Function to Report Problems .....</b>	<b>107</b>
Reading Problem Mail Notification Function .....	107
<b>Management Using SNMP .....</b>	<b>108</b>
<b>ESC/VP21 Commands .....</b>	<b>109</b>
Serial Connection .....	109
Communications protocol .....	109
Command List .....	109
<b>About PJLink .....</b>	<b>111</b>
<b>About Crestron RoomView® .....</b>	<b>112</b>
Operating a Projector from a Computer Window .....	112
Displaying the operation window .....	112
Using the operation window .....	113
Using the tools window .....	114

## Network Functions

<b>Projecting with "Connect to a Network Projector" .....</b>	<b>117</b>
<b>Making a WPS (Wi-Fi Protected Setup) Connection with a Wireless LAN Access Point .....</b>	<b>118</b>
Connection Setup Method .....	118

Making a connection using the push button method .....	119
Making a connection using the PIN Code Method .....	120

## Installation and Connections

<b>Installation Methods .....</b>	<b>124</b>
Switching the Projection Mode .....	124
<b>Connecting to Video Equipment .....</b>	<b>126</b>
Connecting to a Computer .....	126
Changing the video output from a laptop computer. ....	128
Connecting to Video Equipment .....	128
<b>Connecting to External Equipment .....</b>	<b>131</b>
Connecting a LAN Cable .....	131
Connecting to an external monitor .....	131
Connecting to External Speakers .....	131
<b>Installing Optional and Supplied Accessories .....</b>	<b>133</b>
Removing and Attaching the Projector Lens Unit .....	133
Removing .....	133
Attaching .....	134
Installing the Wireless LAN Unit (ELPAP03) .....	134
Attaching .....	134
Reading the wireless LAN indicators .....	135
Attaching and Removing the Cable Cover .....	136
Attaching .....	136
Removing .....	137

## Appendix

<b>Optional Accessories and Consumables .....</b>	<b>139</b>
Optional accessories .....	139
Consumables .....	140

<b>Screen Size and Projection Distance</b> .....	<b>141</b>
Projection Distance .....	141
<b>Supported Monitor Displays</b> .....	<b>143</b>
Supported Monitor Displays .....	143
Computer signals (analog RGB) .....	143
Component Video .....	143
Composite Video/S-Video .....	143
Input signals from DVI-D and HDMI input port .....	143
<b>Specifications</b> .....	<b>145</b>
Projector General Specifications .....	145
<b>Appearance</b> .....	<b>149</b>
<b>Glossary</b> .....	<b>150</b>
<b>General Notes</b> .....	<b>152</b>
About Notations .....	152
General Notice .....	152
<b>Index</b> .....	<b>169</b>



# Introduction

This chapter explains the projector's features and the part names.

## Ease of Use when Installed on a Ceiling Mount

### Centered lens

The lens is positioned in the center of the projector so it is well balanced and is easy to mount on a ceiling. This also makes it easy to line up the screen and the projector.

### Equipped with a horizontal and vertical lens shift

Using the lens shift function that allows you to adjust the position of the projected image along the horizontal and vertical axis opens up a wide variety of installation locations.

☞ p.20

### Five optional lenses are provided

You can select the best lens according to the projection distance and purpose. The bayonet type allows you to simply and easily exchange and install the optional lenses.

☞ p.133, p.139

### A design that harmonizes with the surrounding environment, and makes the installation easy

The projector's sophisticated design has a cable cover in which cables are hidden for a clean exterior appearance.

### Easy maintenance

You can replace the lamp by opening the cover on the side of the projector and pulling it out horizontally.

You can also replace the air filter by simply sliding it out of or into the front of the projector.

## Reliability You can Depend on

A large static electricity filter is used in the air intake system. This reduces the amount of dust that enters the projector to prevent shutdown caused by temperature increases even when the projector is permanently mounted to a ceiling.

## Meets a Wide Range of Needs

### Equipped with a high-resolution WUXGA panel

You can project a dramatic amount of information on the screen. Viewers can see the information at a glance without having to scroll or switch screens.

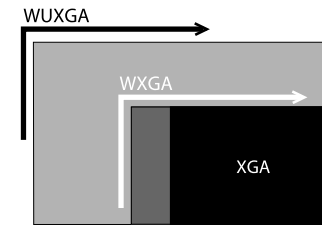

### Project two images simultaneously (Split Screen)

You can simultaneously project the images from two video sources lined up on the screen. This increases the range of applications, such as when holding a video conference while projecting presentation materials. ☞ p.30

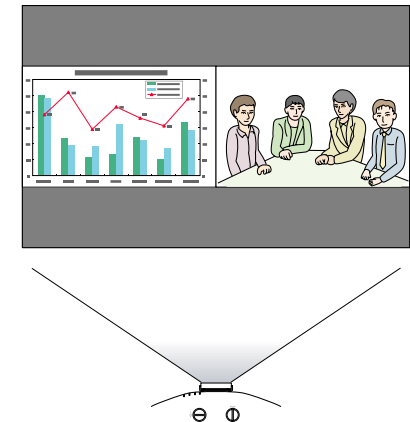

### Clearly reproduce medical images

A color mode called "DICOM SIM" is provided to project medical images, such as X-ray photographs. This mode produces image quality that approaches the DICOM standard.

(The projector is not a medical device and cannot be used for medical diagnosis.)

☞ p.29

### Precise color adjustments



As well as Color Mode, you can also adjust the image's absolute color temperature and the strength of each RGB color. Also, because you can adjust the hue, saturation, and brightness of each RGBCMY, the image can be projected with depth and a color matching in superior detail.

---

## Enhanced Security Functions

### Password Protect to restrict and manage users

By setting a password you can restrict who can use the projector.  [p.45](#)

### Control Panel lock restricts button operation on the control panel.

You can use this to prevent people changing projector settings without permission at events, in schools, and so on.  [p.47](#)

### Equipped with various anti-theft devices

The projector is equipped with the following types of anti-theft security devices.  [p.48](#)

- Security slot
- Security cable installation point
- Screw to fix the lens unit removal button

---

## Easy to Handle

### Direct power On/Off

In places where power is managed centrally, such as in a conference room, the projector can be set to power on and off automatically when the power source to which the projector is connected is switched on or off.

### No cool down delay

After turning the projector's power off, you can disconnect the projector's power cable without having to wait for the projector to cool down.

---

## Monitoring and Control Functions

A selection of monitoring and control protocols is supported, such as the Epson EasyMP Monitor application software. This allows you to use the projector according to your system environment.  "Monitoring and Controls" [p.103](#)

---

## Taking Full Advantage of a Network Connection

### Simultaneously project four images for dynamic conferences

By using the supplied EasyMP Multi PC Projection applications software, the images from up to four computers that are connected to the network can be simultaneously displayed. Anyone can freely and easily project images from connected computers to make conferences and meetings more lively.  [EasyMP Multi PC Projection Operation Guide](#)

### Transferring images and audio using the network

The supplied EasyMP Network Projection applications software can be used to connect to network computers and transfer video, audio, and movies. Using a variety of transfer functions increases presentation possibilities.  [EasyMP Network Projection Operation Guide](#)

### Project using "Connect to a Network Projector"

By connecting the projector to a network and using the Network Projector function in Windows Vista or Windows 7, multiple users on the network can share the projector.  [p.117](#)

### Quick wireless connections to easily connect to the network

Network computers can be easily connected to the projector simply by connecting an optional Quick Wireless Connection USB Key. (This function is supported only for Windows computers.)  [p.139](#)

## Front/Top

The illustration shows the projector with a standard zoom lens installed.

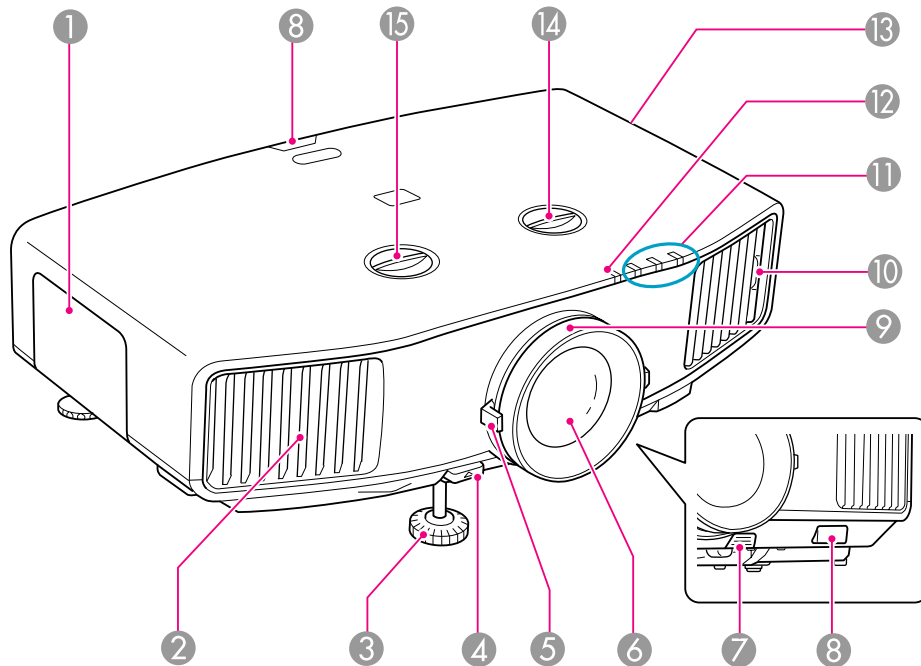

Name	Function
① Lamp cover	Open this cover when replacing the projector's lamp. <a href="#">☛ p.97</a>
② Air exhaust vent	Exhaust vent for air used to cool the projector internally.





**⚠ Caution**

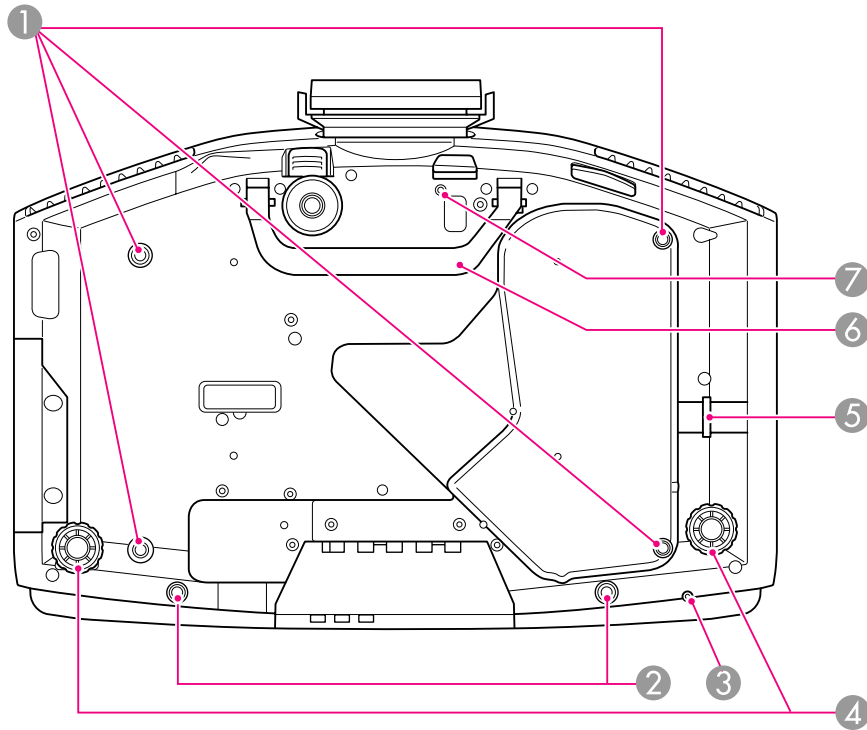

*Do not place objects that may become warped or otherwise affected by heat near the Air exhaust vent and do not put your face or hands near the vent while projection is in progress.*

Name	Function
③ Front adjustable foot	Extend and adjust the position of the projected image when the projector is placed on a surface such as a desk. <a href="#">☛ Quick Start Guide</a>
④ Foot adjust lever	Pull out the foot lever to extend and retract the front foot. <a href="#">☛ Quick Start Guide</a>
⑤ Zoom ring	Adjusts the image size. <a href="#">☛ Quick Start Guide</a>
⑥ Projection lens	Images are projected through here.
⑦ Lens unit removal button	Press this button to remove the lens unit when replacing lens units. <a href="#">☛ p.133</a>
⑧ Remote receiver	Receives signals from the remote control. <a href="#">☛ p.17</a>
⑨ Focus ring	Adjusts the image focus. <a href="#">☛ Quick Start Guide</a>
⑩ Air filter tab	When cleaning or replacing the air filter, use this tab to pull out the air filter. <a href="#">☛ p.94, p.100</a>
⑪ Status indicators	The color of the indicators and whether they are flashing or lit indicate the status of the projector. <a href="#">☛ p.80</a>
⑫ Wireless LAN indicator	This indicator shows the status of network access when the Wireless LAN unit is installed. <a href="#">☛ p.135</a>
⑬ Air intake vent (Air filter)	Takes in air to cool the projector internally. If dust collects here it can cause the internal temperature to rise, and this can lead to problems with operation and shorten the optical engine's service life. Be sure to clean the air filter regularly. <a href="#">☛ p.94</a>
⑭ Vertical lens shift dial	Turn the dial to move the position of the projected image up or down. <a href="#">☛ p.20</a>
⑮ Horizontal lens shift dial	Turn the dial to move the position of the projected image left or right. <a href="#">☛ p.20</a>

## Base





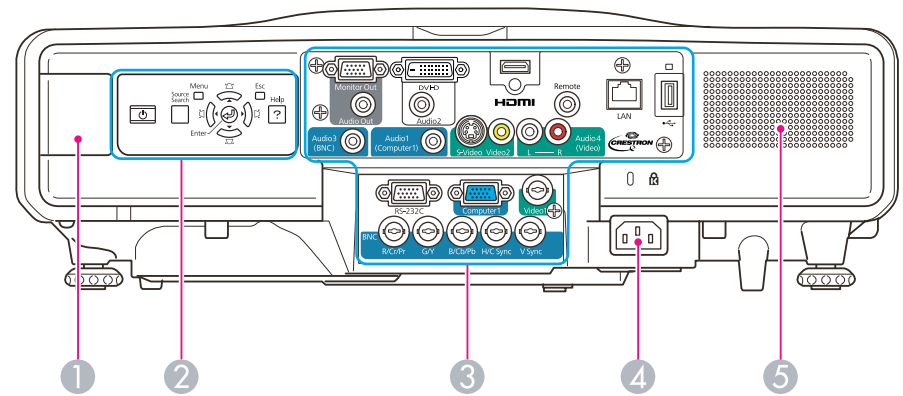

Name	Function
1 Ceiling mount fixing points (4 points)	Attach the optional ceiling mount here when suspending the projector from a ceiling.  p.139, p.124
2 Screw holes to fix the cable cover	Holes for screws to fix the cable cover in place.  p.136
3 Screw hole to fix Wireless LAN unit	When installing the Wireless LAN unit, use this screw hole to fix the unit in place to avoid loss and so on.  p.134
4 Rear foot	When setup on a desk, turn to extend and retract to adjust the horizontal tilt.  Quick Start Guide

Name	Function
5 Security cable installation point	Pass a commercially available anti-theft wire lock through here when you want to secure the projector to a fixed object.  p.48
6 Handle	Use these handles when carrying the projector.
7 Screw hole for the screw to fix the lens unit removal button	When installing a lens unit, use this screw hole to fix the lens unit removal button using the screw supplied.  p.48

## Rear



Name	Function
1 Wireless LAN unit installation section	Install the Wireless LAN unit here. Remove the cover when installing.  "Installing the Wireless LAN Unit (ELPAP03)" p.134
2 Control Panel	 "Control Panel" p.13
3 Interface	 "Interface" p.12
4 Power inlet	Connects to the power cable.  Quick Start Guide
5 Speaker	

## Interface

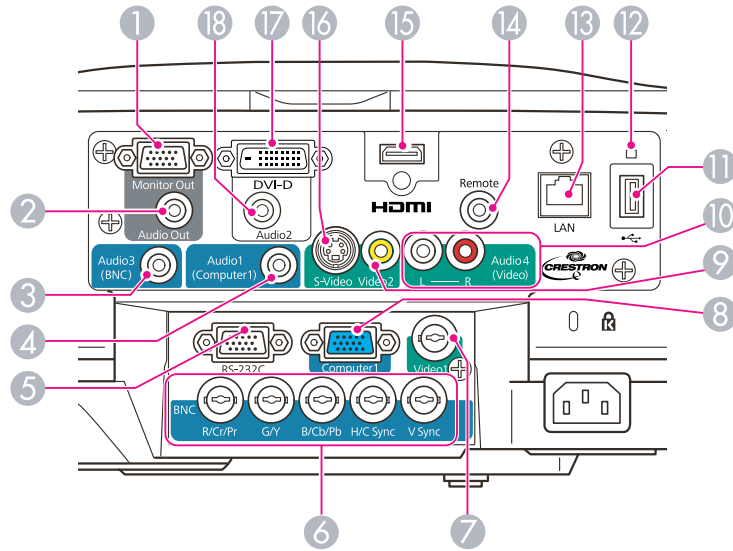

Name	Function
1 <b>Monitor Out port</b>	Outputs to an external monitor the analog RGB signal from the computer connected to the Computer1 input port or BNC input port. The signals that are input from other ports and component video signals cannot be output.
2 <b>Audio Out port</b>	Outputs the sound of the image currently being projected to external speakers.
3 <b>Audio3 input port</b>	Connects to the audio out port of the device that is connected to the BNC input port.
4 <b>Audio1 input port</b>	Connects to the audio out port of the device that is connected to the Computer1 input port.

Name	Function
5 <b>RS-232C port</b>	When controlling the projector from a computer, connect it to the computer with an RS-232C cable. This port is for control use and should not normally be used. ☛ "ESC/VP21 Commands" p.109
6 <b>BNC input port</b>	For analog RGB signals from a computer and component video signals from other video sources.
7 <b>Video1 input port</b>	For composite video signals from video sources.
8 <b>Computer1 input port</b>	For analog RGB signals from a computer and component video signals from other video sources.
9 <b>Video2 input port</b>	For composite video signals from video sources.
10 <b>Audio4 input port</b>	Connects to the audio out port when you want to output audio from the projector from equipment connected to the S-Video input port, Video1 input port, or Video2 input port.
11 <b>USB(TypeA) port</b>	Connects a USB storage device or a digital camera, and projects image/movie files and scenarios. ☛ <a href="#">PC Free Operation Guide</a>
12 <b>USB indicator</b>	The following explains the status of USB devices connected to USB(TypeA) port. OFF: USB device is not connected Orange Light ON: USB device is connected Green Light ON: USB device is operating Red Light ON: Error
13 <b>LAN port</b>	Connects a LAN cable to connect to a network.
14 <b>Remote port</b>	Connects the optional remote control cable set and inputs signals from the remote control. When the remote control cable is plugged into this remote port, the remote receiver on the projector is disabled.
15 <b>HDMI input port</b>	Inputs video signals from HDMI™ compatible video equipment and computers. This projector is compatible with <a href="#">HDCP</a> signals.
16 <b>S-Video input port</b>	For S-video signals from video sources.

Name	Function
17 <b>DVI-D input port</b>	Inputs digital RGB signals from a computer connected to the DVI-D output port. This projector is compatible with <a href="#">HDCP</a> signals.
18 <b>Audio2 input port</b>	Connects to the audio out port of the device that is connected to the DVI-D input port.

## Control Panel

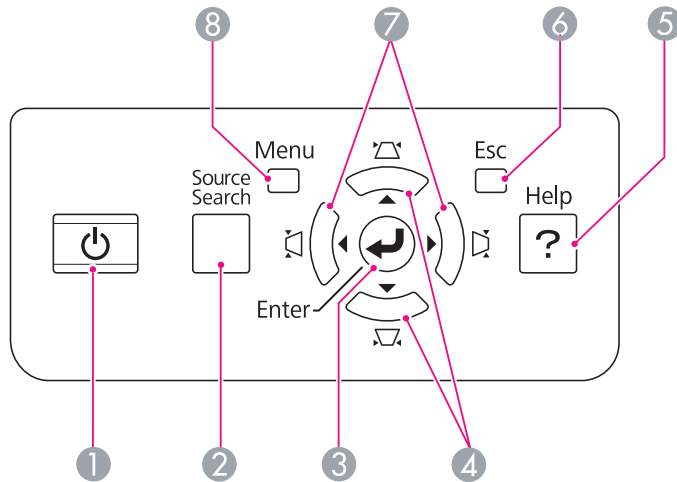







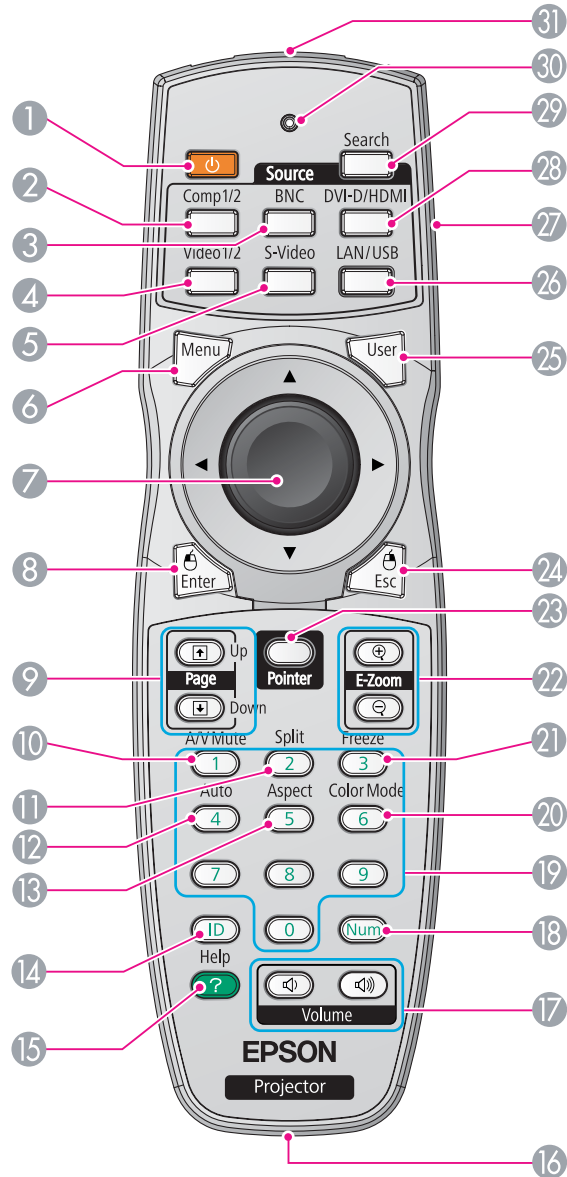







Name	Function
1 <b>[Power] button</b>	Turns the projector power On or Off. <a href="#">Quick Start Guide</a>
2 <b>[Source Search] button</b>	Changes to the next input source that is connected to the projector and is sending an image. <a href="#">p.25</a>





Name	Function
3 <b>[Enter] button</b>	If pressed during projection of computer analog RGB signals, it automatically adjusts the Tracking, Sync., and Position to project the optimum image. When the configuration menu or a Help screen is displayed, it accepts and enters the current selection and moves to the next level. <a href="#">p.50</a>
4 <b>[Up/Down] button</b>	Corrects vertical keystone distortion. <a href="#">p.23</a> If pressed while the configuration menu or a Help screen is displayed, these buttons only have the [Up] and [Down] functions which select menu items and setting values. <a href="#">p.50</a> When projecting using PC Free or Connect to a Network Projector, these buttons function only as [Up] and [Down] buttons.
5 <b>[Help] button</b>	Displays and closes the Help screen which shows you how to deal with problems if they occur. <a href="#">p.78</a>
6 <b>[Esc] button</b>	Stops the current function. If pressed when the configuration menu is displayed, it moves to the previous menu level. <a href="#">p.50</a>
7 <b>[Left/Right] button</b>	Corrects horizontal keystone distortion. <a href="#">p.23</a> If pressed while the configuration menu or a Help screen is displayed, these buttons only have the [Left] and [Right] functions which select menu items and setting values. <a href="#">p.50</a> When projecting using PC Free or Connect to a Network Projector, these buttons function only as [Left] and [Right] buttons.
8 <b>[Menu] button</b>	Displays and closes the configuration menu. <a href="#">p.49</a>

## Remote Control



Name	Function
① [Power] button	Turns the projector power On or Off.  <i>Quick Start Guide</i>
② [Comp1/2] button	Changes to images from the Computer1 input port.
③ [BNC] button	Changes to images from the BNC input port.
④ [Video1/2] button	Each time the button is pressed, the image displayed changes between Video1 input port and Video2 input port.
⑤ [S-Video] button	Changes to images from the S-video input port.
⑥ [Menu] button	Displays and closes the configuration menu.  <a href="#">p.49</a>
⑦ [Directional] button	When the configuration menu or Help screen is displayed, it selects menu items and setting values.  <a href="#">p.50</a> , <a href="#">p.78</a> When using the optional wireless mouse receiver, the pointer moves in the direction (eight possible directions) that the button is pressed.
⑧ [Enter] button	When the configuration menu or a Help screen is displayed, it accepts and enters the current selection and moves to the next level.  <a href="#">p.50</a> , <a href="#">p.78</a> Acts as a mouse's left button when using the optional wireless mouse receiver.
⑨ [Page] buttons [Up][Down]	These buttons can be used to page up and down when projecting an image from a computer that is connected to the projector through the network. These buttons can be used to switch the screen when projecting with PC Free. These buttons can be used to page up and down when using the optional wireless mouse receiver.
⑩ [A/V Mute] button	Turns the video and audio on or off.  <a href="#">p.34</a>
⑪ [Split] button	Press this button to split the screen in two and project two images simultaneously.  <a href="#">p.30</a>
⑫ [Auto] button	If pressed during projection of computer analog RGB signals, it automatically adjusts the Tracking, Sync., and Position to project the optimum image.

Name	Function
13 [Aspect] button	The <u>Aspect Ratio</u> changes each time the button is pressed.  p.27
14 [ID] button	Press to set the remote control ID.  p.39
15 [Help] button	Displays and closes the Help screen which shows you how to deal with problems if they occur.  p.78
16 Remote port	Connects the optional remote control cable set and outputs signals from the remote control. When the remote control cable is plugged into this remote port, the remote receiver is disabled.
17 [Volume] button [<img alt="volume down icon" data-bbox="75 420 90 435"/>][<img alt="volume up icon" data-bbox="100 420 115 435"/>	[<img alt="volume down icon" data-bbox="205 395 220 410"/>] Decreases the volume. [<img alt="volume up icon" data-bbox="245 395 260 410"/>] Increases the volume.  <i>Quick Start Guide</i>
<div style="border: 1px solid black; padding: 5px; background-color: #e0f2f1;">  <b>Caution</b>                      Do not start when the volume is set too high. Loud sounds may cause loss of hearing. Always lower the volume before turning off the projector. Gradually increase the volume after turning on the projector.                 </div>	
18 [Num] button	Use this button to enter passwords, IP Address from the Network, and so on.
19 Numeric buttons	Use this button to enter passwords, remote control ID settings, IP Address from the Network, and so on.
20 [Color Mode] button	Each time the button is pressed, the Color Mode changes.  p.29
21 [Freeze] button	Images are paused or unpaused.  p.34
22 [E-Zoom] buttons [<img alt="zoom in icon" data-bbox="75 820 90 835"/>][<img alt="zoom out icon" data-bbox="100 820 115 835"/>	The [<img alt="zoom in icon" data-bbox="75 800 90 815"/>] button enlarges the image without changing the projection size. The [<img alt="zoom out icon" data-bbox="100 845 115 860"/>] button reduces the parts of images that have been enlarged using the [<img alt="zoom in icon" data-bbox="75 800 90 815"/>] button.  p.36
23 [Pointer] button	Press to activate the on screen pointer.  p.35

Name	Function
24 [Esc] button	Stops the current function. If pressed when the configuration menu is displayed, it moves to the previous menu level.  p.50 Acts as a mouse's right button when using the optional wireless mouse receiver.
25 [User] button	Press to assign a frequently used item from the six available configuration menu items. By pressing the button the assigned menu item selection/adjustment screen is displayed, allowing you to make one-touch settings/adjustments.  p.55 <b>Test Pattern</b> is assigned as the default setting.
26 [LAN/USB] button	Each time you press this button, the image is switched between the image from a computer that is connected to the projector through the network and the image from the USB device that is connected to the USB(TypeA) port.
27 ID switch	Use this switch to enable (On)/disable (Off) ID settings for the remote control.  p.38
28 [DVI-D/HDMI] button	Each time the button is pressed, the image displayed changes between DVI-D input port and the HDMI input port.
29 [Source Search] button	Changes to the next input source that is connected to the projector and is sending an image.  p.25
30 Indicators	A light is emitted when outputting remote control signals.
31 Remote control light-emitting area	Outputs remote control signals.

## Installing the batteries

The batteries are not set in the remote control when it is sold. Set the supplied batteries (two, AA alkaline batteries) to use the remote control.

## Attention

Make sure you read the Safety Instructions before handling the batteries.   
[Safety Instructions](#)

## Procedure

### 1 Remove the battery cover.

While pushing the battery compartment cover catch, lift the cover up.

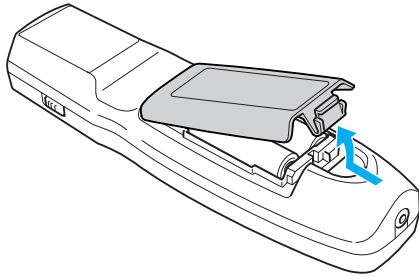

### 2 Insert the batteries in the correct direction.

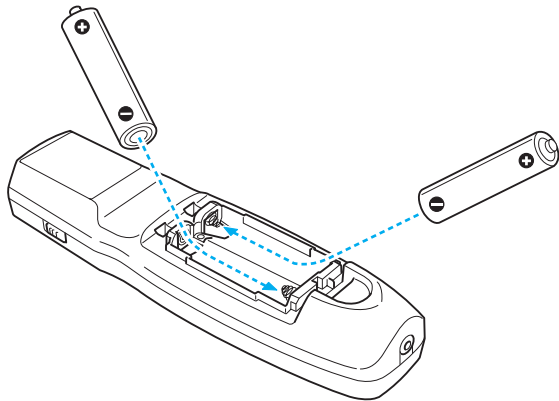

## Caution

Check the positions of the (+) and (-) marks inside the battery holder to ensure the batteries are inserted the correct way.

### 3 Replace the battery cover.

Press the battery compartment cover until it clicks into place.

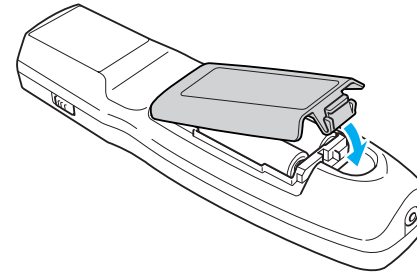

If delays in the responsiveness of the remote control occur or if it does not operate after it has been used for some time, it probably means that the batteries are becoming flat. When this happens, replace them with new batteries. Have two AA size alkaline batteries ready. You cannot use other batteries except for the AA size alkaline.



## Operating range of remote control

When using the remote control, point the remote control light-emitting area at the remote receiver on the projector. The operating range of the remote control that is provided with the projector is shown below.

### Horizontal operating range

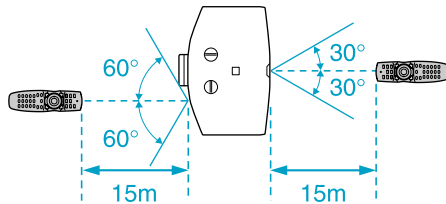

### Vertical operating range

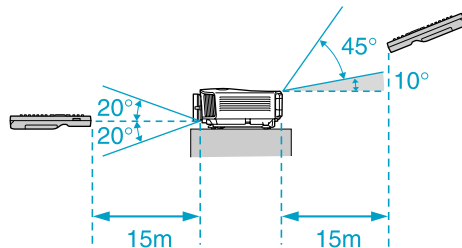

- To restrict reception of the operation signals from the remote control, set the **Remote Receiver** on the **Set** menu. [p.55](#)
- When using a remote control provided with other Epson projectors, set the **Remote Control Type** on the **Extended** menu. [p.57](#)  
The operating range will depend on the remote control that you use.



# Useful Functions

This chapter explains useful tips for giving presentations, and the security functions.

## Displaying a Test Pattern

A test pattern can be displayed to adjust the projection status without connecting video equipment. This is useful when installing a projector.



If the [User] button on the remote control is set to **Test Pattern**, the test pattern will be displayed when the [User] button is pressed. (The default setting is Test Pattern.)

### Procedure

- 1 Press the [Menu] button while the projector is projecting. Select Settings - "Test Pattern", then press the [Enter] button.

Using the Remote Control

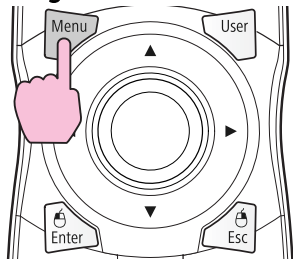

Using the Control panel

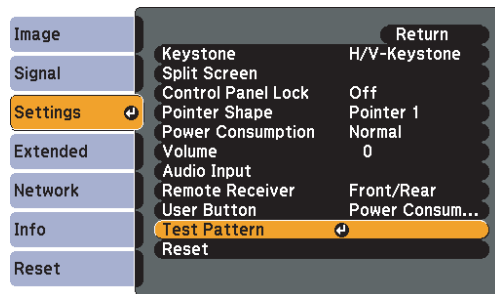
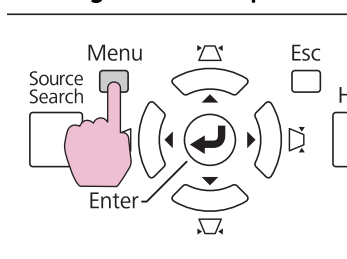

[Esc]:Return [◄]:Select [Enter]:Enter [Menu]:Exit



Press the [◄] button on the remote control in the [▶] direction or press the [Enter] button on the control panel to switch the test pattern.

To display the previous image, press the [◄] button on the remote control in the [◀] direction.



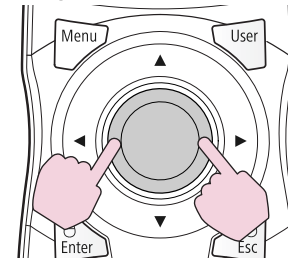



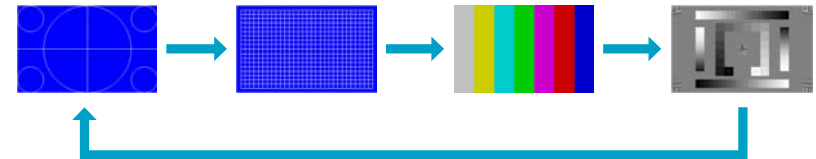
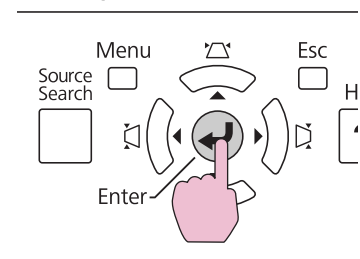

Using the Remote Control



Using the Control panel



The following adjustments can be made while the test pattern is being displayed.

- Zoom and focus adjustment  [Quick Start Guide](#)
- Projected image position adjustment  [p.20](#)
- Projected image keystone correction  [p.20](#)
- Selecting the projection quality (Selecting Color Mode)  [p.29](#)
- Brightness adjustment  Image menu - Brightness [p.51](#)
- Sharpness adjustment (Standard only)  Image menu - Sharpness [p.51](#)
- Color temperature adjustment  Image menu - Abs. Color Temp. [p.51](#)
- Color adjustment  Image menu - Color Adjustment [p.51](#)



To set menu items that cannot be set while the test pattern is being displayed or to fine-tune the projected image, project an image from the connected device.

3

Press the [Esc] button to end the test pattern.

## Adjusting the Position of the Projected Image (Lens Shift)

The lens can be shifted to adjust the position of the projected image, for example, when the projector cannot be installed directly in front of the screen.

### Procedure

Turn the vertical lens shift dial or horizontal lens shift dial on the projector to adjust the location of the projected image.

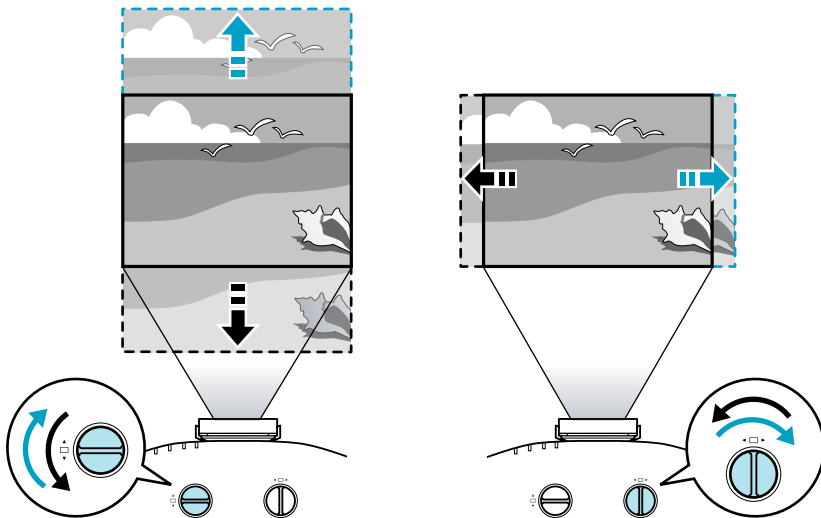

The image will be clearest when both the vertical and horizontal lens shift dials are set in the center.

The ranges within which the image can be moved using the lens shift dials are shown below.

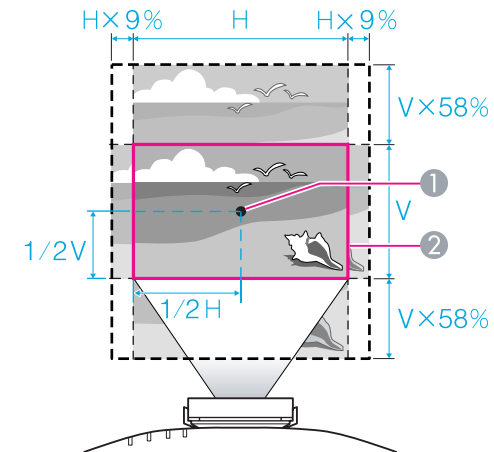

- 1 Center of lens
- 2 Projected image when lens shift dials are set in the center

## Correcting Distortion in the Projected Image

There are two methods of correcting distortion in projected images as below.

- Quick Corner  
This allows you to manually correct each of the four corners of the projected image separately.  "Quick Corner" p.21  
We recommend using Quick Corner to accurately adjust keystone distortion.

- H/V-Keystone

This allows you to manually correct distortion in the horizontal and vertical directions independently. You can perform easy H/V-Keystone corrections by using the [↔/▲], [↔/▼], [↔/◀] and [↔/▶] buttons on the projector's control panel. 🖱️ "H/V-Keystone" p.23

Quick Corner and horizontal and vertical keystone cannot be performed at the same time. When the **Keystone** correction method is selected from the Configuration menu, the correction method you choose is assigned to the control panel [↔/▲], [↔/▼], [↔/◀] and [↔/▶] buttons. The default setting for **Keystone** is set to **H/V-Keystone**, so when [↔/▲], [↔/▼], [↔/◀] and [↔/▶] buttons are pressed, H/V-Keystone correction is carried out.

Because Quick Corner and H/V-Keystone correction can be carried out while projecting a test pattern, you do not need to make preparations by connecting a computer or other equipment.

## Quick Corner

### Procedure

1

Press the [Menu] button while the projector is projecting. Select Settings menu - "Keystone" and then press the [Enter] button. 🖱️ "Using the Configuration Menu" p.50

Using the Remote Control

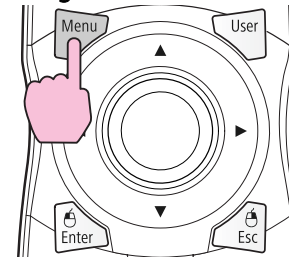

Using the Control panel

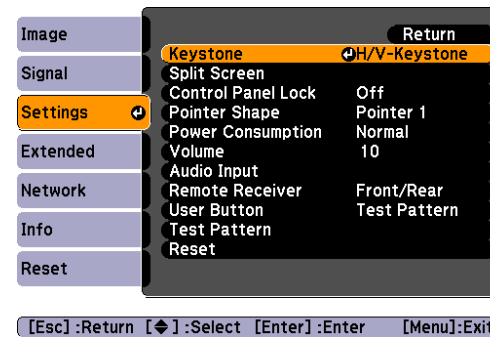
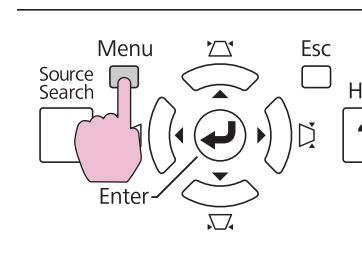

2

Select "Quick Corner", and then press the [Enter] button.

Press the [Enter] button again to display the selection screen from which you can select one of four corners.

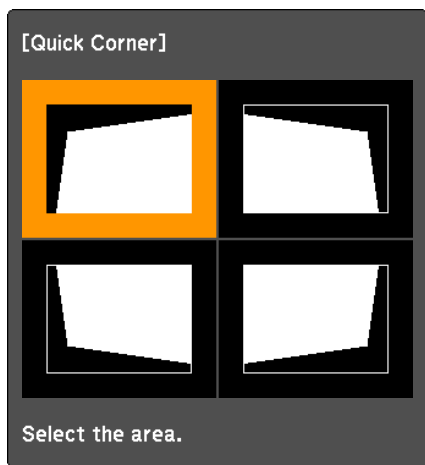

[◀/▶]: Select  
 [Enter]: Enter  
 [Esc]: Return (press for 2 seconds to reset/switch)

**3** Use the [⊙] button on the remote control or the [△/▲], [▽/▼], [◀/▶] and [↶/↷] buttons on the control panel to select the corner you want to adjust, and then press the [Enter] button.

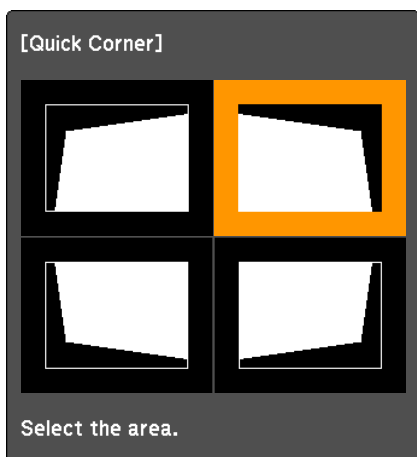

**4** Correct the position of the corner using the [⊙] button on the remote control, or the [△/▲], [▽/▼], [◀/▶] and [↶/↷] buttons on the control panel.

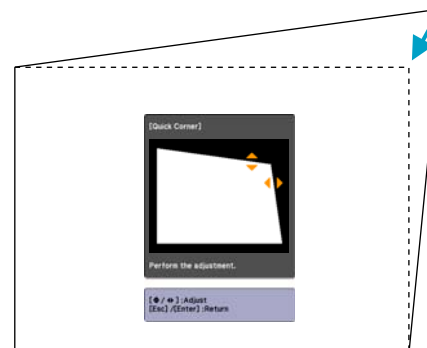

If the triangle in the direction you are adjusting the shape turns gray, as shown in the screenshot below, you cannot adjust the shape any further in that direction.

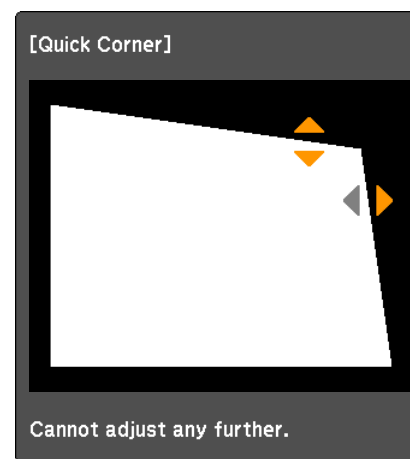

**5** Repeat procedures 3 and 4 as needed to adjust any remaining corners.

**6** When you are done, press the [Esc] button to exit the correction menu.

Because the correction method was changed to **Quick Corner** from **Keystone** in the configuration menu, when [↖/▲], [↘/▼], [↙/◀] and [↗/▶] buttons are pressed later, the screen for selecting the corner in procedure 2 is displayed. Change **Keystone** from the configuration menu to **H/V-Keystone** if you want to correct H/V-Keystone when pressing the [↖/▲], [↘/▼], [↙/◀] and [↗/▶] buttons on the control panel.  p.55



If the [Esc] button is held down for about two seconds while correcting with Quick Corner, the following screen is displayed.

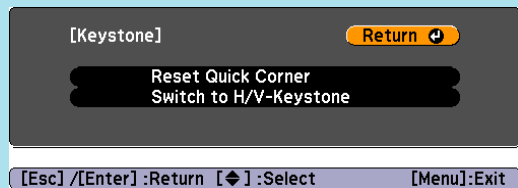

**Reset Quick Corner:** Resets the result of Quick Corner corrections.  
**Switch to H/V-Keystone:** Switches the correction method to H/V-Keystone.  "H/V-Keystone" p.23



This adjustment can also be made from **H/V-Keystone** on the **Settings** menu.  p.55

• Correcting vertical keystone

Vertical keystone can be corrected to a vertical projector tilt of up to 30° against the screen. If you use the projector tilted at an angle of more than 30°, it could be damaged and cause an accident.

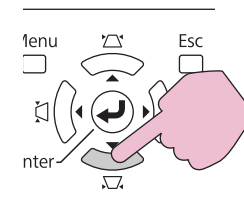
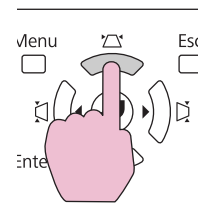
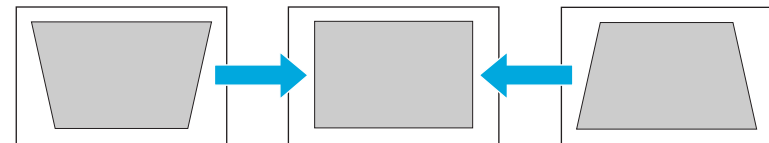

If the [↖/▲] and [↘/▼] buttons are pressed simultaneously for at least 1 second, the value of vertical keystone will return to the original status.

## H/V-Keystone

### Procedure

Press the [↖/▲], [↘/▼], [↙/◀] and [↗/▶] buttons on the control panel to adjust keystone settings in the horizontal and vertical directions independently.

- Correcting horizontal keystone  
Horizontal keystone can be corrected to a horizontal projector tilt of up to 20°.

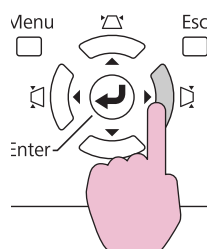
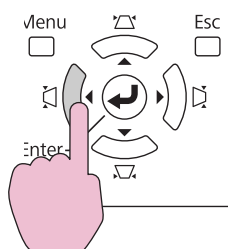
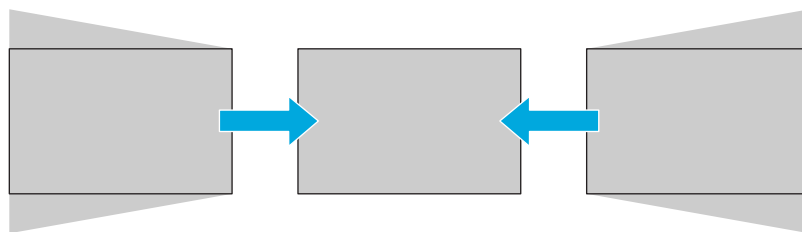
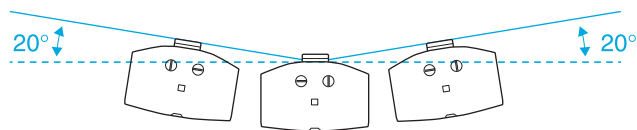

If the [←/→] and [↶/↷] buttons are pressed simultaneously for at least 1 second, the value of horizontal keystone will return to the original status.



Shift the lens to the position shown below when performing horizontal and vertical keystone. When the lens shift is not positioned as below, the distortion is not corrected accurately. ➡ "Adjusting the Position of the Projected Image (Lens Shift)" p.20

- The horizontal lens shift is set to the center.
- The vertical lens shift is set to the top or bottom.

The correction may not be properly performed according to the zoom adjustment value. And, the projected screen size may become smaller after performing the correction. Be careful about the projection distance when installing the projector.

Correct the image using Quick Corner to precisely align the projected image with the screen or to fine-tune the image. ➡ "Quick Corner" p.21



You can change the projected image in the following two ways.

- Changing by Source Search  
The projector automatically detects signals being input from connected equipment, and the image being input from the input port is projected.
- Changing directly to the target image  
You can use the remote control buttons to change to the target input port.

## Automatically Detect Input Signal and Change the Projected Image (Source Search)

You can project the target images quickly by pressing the [Source Search] button because it will switch only to images from input ports to which image signals are being input.

### Procedure

**When your video equipment is connected, start playback before beginning this operation. When two or more pieces of equipment are connected, press the [Source Search] button until the target image is projected.**

Using the Remote Control

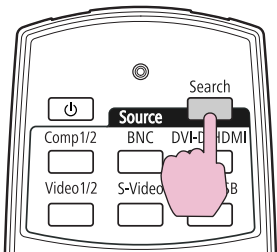

Using the Control panel

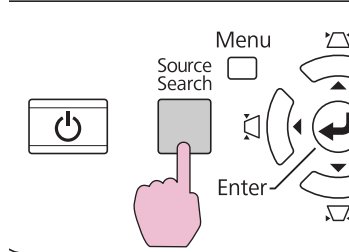

When the [Source Search] button is pressed, a search is made for input ports to which video signals are being input in the following order. (The input port where no image signal is being input is skipped.)

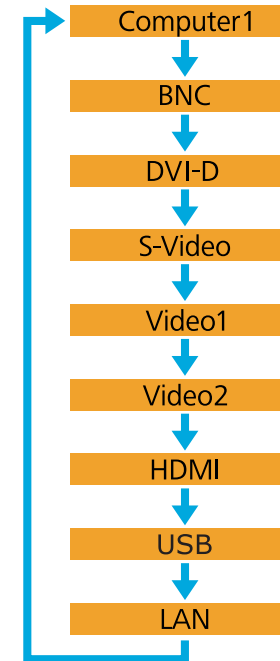

When switching to LAN, images from computers connected through the network are projected.



The following screen showing the status of image signals remains displayed when only the image that the projector is currently displaying is available, or when no image signal can be found. You can select the input port where the equipment you want to use is connected. If no operation is performed after about 10 seconds, the screen closes.

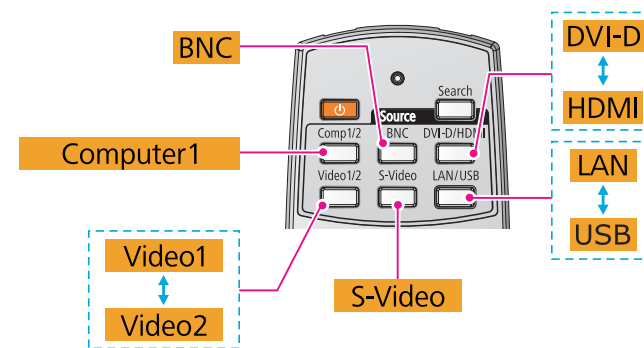

## Switch to the Target Image by Remote Control

You can change directly to the image from the target input port by pressing the following buttons on the remote control.  "Remote Control" [p.14](#)

When switching to LAN, images from computers connected through the network are projected.

You can select the aspect mode according to the type of input signal, ratio of height and width, and resolution to switch the Aspect Ratio of the projected image. The aspect modes are listed below. The aspect modes that can be set depend on the type of image that is being projected.

Aspect mode	Explanation
<b>Normal</b>	Projects to the full projection size retaining the aspect ratio of the input image.
<b>Auto</b>	Projects in an appropriate aspect ratio based on information from the signal being input.
<b>16:9</b>	Projects to the full projection size at an aspect ratio of 16:9.
<b>Full*</b>	Project at full size.
<b>Zoom</b>	Projects the input image enlarged to the full lateral direction size as the aspect ratio remains. Parts that extend beyond the projection size are not projected.
<b>Native</b>	Projects at the resolution of the input image size to the center of the screen. This is ideal for projecting clear images.

\* To select **Full** while inputting 1080i signal, set **Progressive** in the Configuration menu to **Off**. p.53

## Procedure

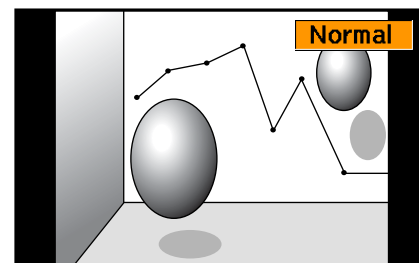
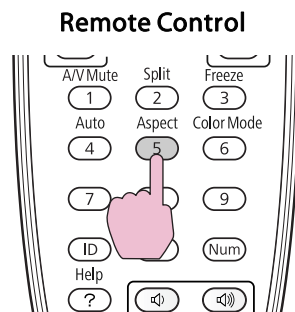

The aspect mode name is displayed on the screen by pressing the button. If you press the button while the aspect mode name is displayed on the screen, it changes to the next aspect mode.



The aspect mode can also be set using **Aspect** in the **Signal** menu from the configuration menu. p.53

## Changing the Aspect Mode

### Projecting images from video equipment or from the HDMI input port

Each time the [Aspect] button on the remote control is pressed, the aspect mode changes in the order **Auto**, **16:9**, **Full**, **Zoom**, and **Native**.

p.27

Example: 720p signal input (resolution: 1280x720, aspect ratio: 16:9)

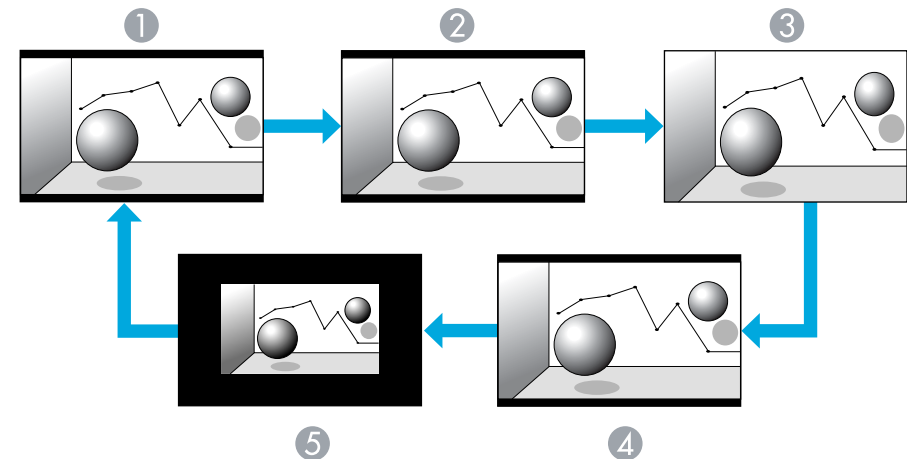

- ① Auto
- ② 16:9

- ③ Full
- ④ Zoom
- ⑤ Native

## Projecting images from a computer

Each time the [Aspect] button on the remote control is pressed, the aspect mode changes in the order **Normal**, **16:9**, **Full**, **Zoom**, and **Native**.

☞ [p.27](#)

Projection examples for each aspect mode are shown below.

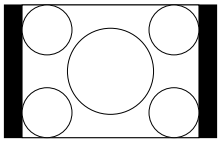
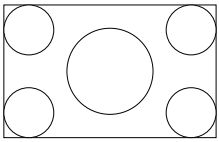
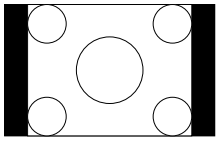
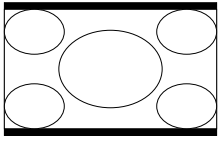
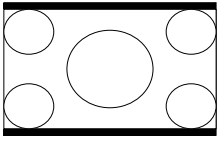
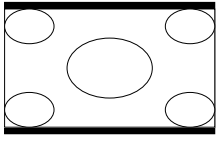
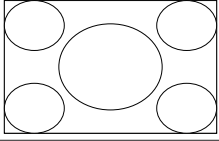
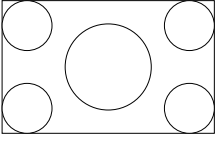
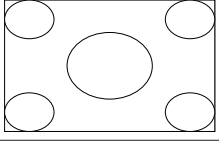
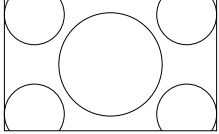
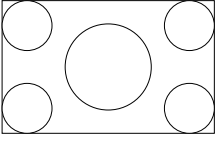
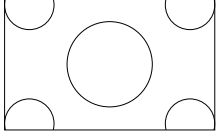
Aspect mode	Input Signal		
	XGA 1024X768(4:3)	WXGA 1280X800(16:10)	SXGA 1280X1024(5:4)
<b>Normal</b>			
<b>16:9</b>			
<b>Full</b>			
<b>Zoom</b>			

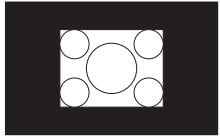
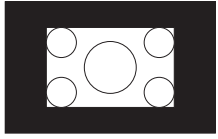
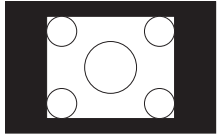
Aspect mode	Input Signal		
	XGA 1024X768(4:3)	WXGA 1280X800(16:10)	SXGA 1280X1024(5:4)
<b>Native</b>			



If parts of the image are missing or it cannot project everything, set **Wide** or **Normal** in **Resolution** from the configuration menu depending on the size of the computer panel. ☞ [p.53](#)

You can easily obtain the optimum image quality simply by selecting the setting that best corresponds to your surroundings when projecting. The brightness of the image varies depending on the mode selected.

Mode	Application
<b>Dynamic</b>	Ideal for use in a bright room. This is the brightest mode.
<b>Presentation</b>	Ideal for making presentations using color materials in a bright room.
<b>Theatre</b>	Ideal for watching films in a dark room. Gives images a natural tone almost like an original source.
<b>Photo*1</b>	Ideal for projecting still pictures, such as photos, in a bright room. The images are vivid and brought into contrast.
<b>Sports*2</b>	Ideal for watching TV programmes in a bright room. The images are vivid and brought to life.
<b>sRGB</b>	Ideal for images that conform to the <u>sRGB</u> color standard.
<b>DICOM SIM*1</b>	Ideal for projecting X-ray photographs and other medical images. This produces images with clear shadows. The projector is not a medical device and cannot be used for medical diagnosis.
<b>Customized</b>	Select <b>Customized</b> to adjust <b>R,G,B,C,M,Y</b> from <b>Color Adjustment</b> in the configuration menu.

\*1 This can be selected when inputting RGB signals, or when USB or LAN is selected as the input source.

\*2 This can be selected when inputting component video signals, S-video signals, or composite video signals.

## Procedure

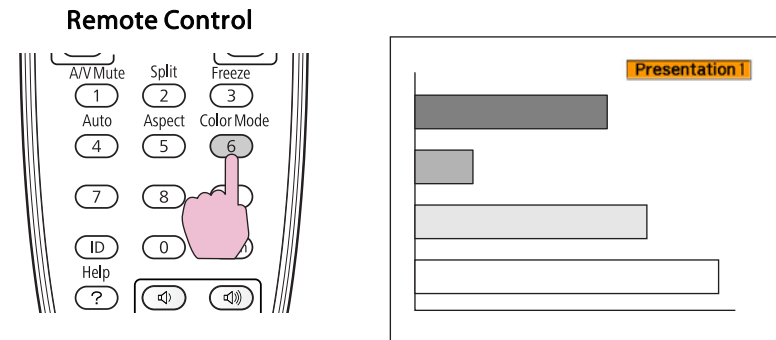

The Color Mode name is displayed on the screen by pressing the button. If you press the button while the Color Mode name is displayed on the screen, it changes to the next Color Mode.



The color mode can also be set using **Color Mode** in the **Image** menu from the configuration menu. [p.51](#)

A split screen can be used to divide the screen into a left screen (A) and a right screen (B) and simultaneously project two images.

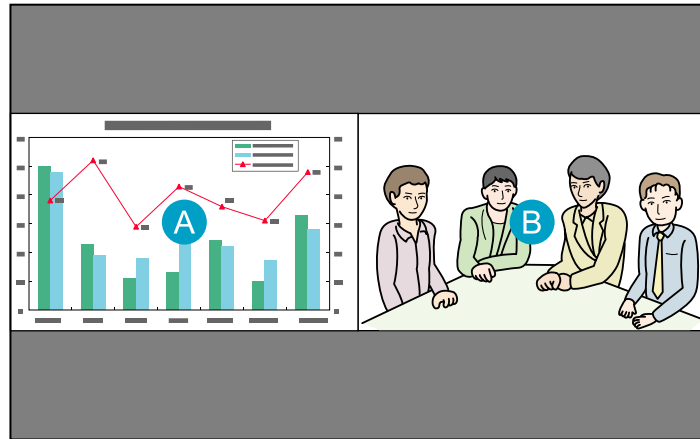

## Input Sources for Split Screen Projection

The combinations of input sources that can be projected on a split screen are listed below.

Images from computers connected through the network or images from the USB(TypeA) port cannot be projected.

Left or right screen	Other screen
DVI-D	Computer1
HDMI	BNC
	S-Video
	Video1
	Video2

## Operating Procedures

### Projecting on a split screen

#### Procedure

- 1 Press the [Split] button on the remote control while the projector is projecting.

The currently selected input source will be displayed on the left screen.

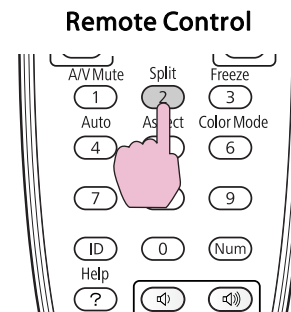

The split screen can also be started from **Split Screen** on the Configuration menu. p.55

- 2 Press the [Menu] button on the remote control or the control panel.

The **Split Screen Setup** will be displayed.

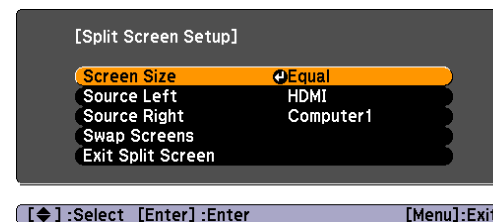



The **Split Screen Setup** will also be displayed when the [Source Search] button is pressed on the remote control or control panel or when a Source button is pressed on the remote control.

3

To switch the image projected on the left screen, select "Source Left" and press the [Enter] button. To switch the image projected on right screen, select "Source Right" and press the [Enter] button.

4

Select the input source to project and press the [Enter] button.

Only the input sources that can be combined can be selected.

☛ "Input Sources for Split Screen Projection" p.30

To switch the projected image during split screen projection, start the procedure from step 2.



- The audio from the input source that is selected for the left screen will be output.
- If **Computer1** or **BNC** is selected for the left screen, the image for the left screen can be displayed on an external monitor. (This is possible only when analog RGB signals are input.) ☛ p.131

## Switching the left and right screens

Use the following procedure to switch the images displayed on the left and right screens.

### Procedure

1

Press the [Menu] button on the remote control or the control panel during split screen projection.

2

Select "Swap Screens" and then press the [Enter] button.

The images on the left and right screens will be swapped.

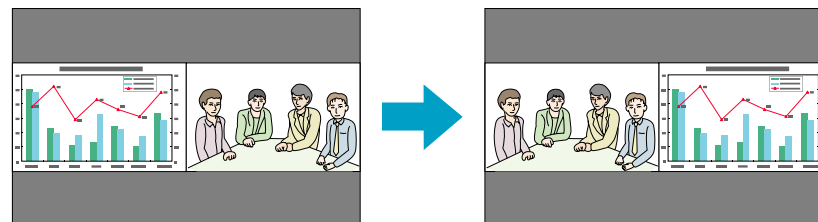

## Switching the left and right image sizes

### Procedure

1

Press the [Menu] button on the remote control or the control panel during split screen projection.

2

Select "Screen Size" and then press the [Enter] button.

3

Select the image size to display and then press the [Enter] button.

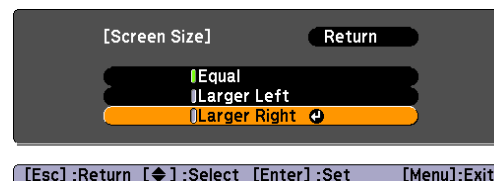

4

Press the [Menu] button to end the setting procedure.

The projected images will appear as shown below after setting the screen size.

**Equal**



**Larger Left**



**Larger Right**

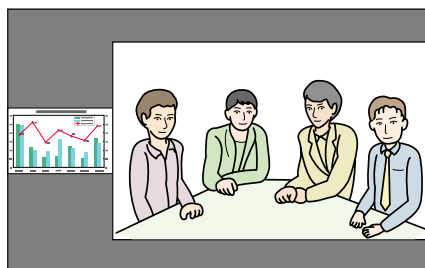

- You cannot enlarge both the left screen and right screen images at the same time.
- When one image is enlarged, the other image is reduced.
- Depending on the video signals that are input, the images on the left and right may not appear to be the same size even if **Equal** is set.

## Ending the split screen

### Procedure

To end the split screen, press the [Esc] button on the remote control or control panel.

The following steps can also be used to end the split screen.

- Press the [Split] button on the remote control.
- Select **Exit Split Screen** in the **Split Screen Setup** and then press the [Enter] button.

---

## Restrictions during Split Screen Projection

### Operating restrictions

The following operations cannot be performed during split screen projection.

- Setting the Configuration Menu
- E-zoom
- Switching the aspect mode (The aspect mode will be set to **Normal**.)  
☞ [p.27](#)
- Operations using the [User] button on the remote control

Help can be displayed only when image signals are not input or when an error or warning notification is displayed.





### Restriction relating to images

- The default values for the **Image** menu are applied to the image on the right screen. However, the settings for the image projected on the left screen are applied to the image on the right screen for the **Color Mode**, **Abs. Color Temp.**, and **Color Adjustment**. Also, the **Advanced** settings for **Sharpness** (Thin Line Enhancement, Thick Line Enhancement) are ignored for the images on both screens. 🖱️ [p.51](#)
- The settings for **Progressive**, **Noise Reduction**, and **2-2 Pull-down** are set to **Off**. 🖱️ Signal menu [p.53](#)
- The default setting for the **Overscan** is applied. 🖱️ Signal menu - Overscan [p.53](#)
- The display screen will be **Blue** when there is no image signal input.
- When the A/V Mute operation is performed, the display screen will be **Black**.

## Hiding the Image and Sound Temporarily (A/V Mute)

You can use this when you want to focus the audience's attention on what you are saying, or if you do not want to show details such as when you are changing between files during presentations from a computer.

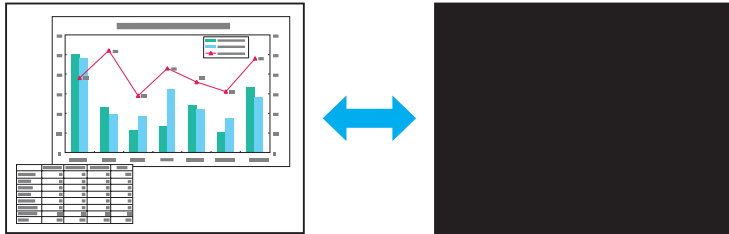

### Procedure

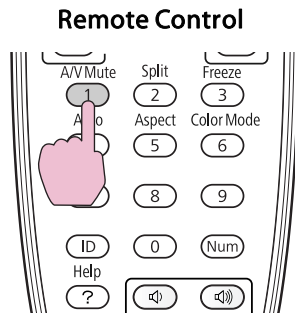

Each time you press the button, A/V Mute turns on or off.



- If you use this function when projecting moving images, the images and sound continue to be played back by the source, and you cannot return to the point where A/V Mute was activated.
- You can set the A/V Mute display status to **Black**, **Blue**, or **Logo** from **Extended** menu - **A/V Mute**.  p.57
- The lamp is still lit during A/V Mute, so the lamp time continues to accumulate.

## Freezing the Image (Freeze)

When the freeze function is activated on moving images, the frozen image continues to be projected on the screen, so you can project a moving image one frame at a time like a still photo. Also, you can perform operations such as changing between files during presentations from a computer without projecting any images if the freeze function is activated beforehand.

### Procedure

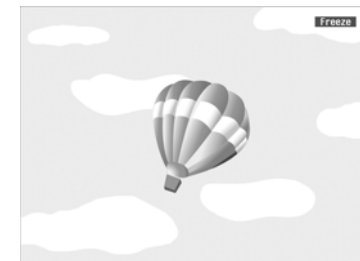
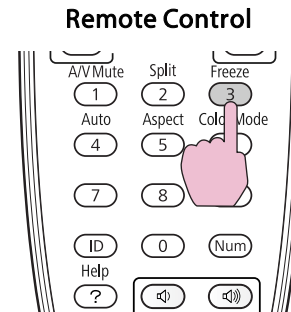

Each time you press the button, Freeze turns on or off.



- Audio does not stop.
- The image source continues to play back the moving images even while Freeze is on, and so it is not possible to resume projection from the point where it was paused.
- If the [Freeze] button is pressed while the configuration menu or a Help screen is displayed, the menu or Help screen being displayed is cleared.
- Freeze still works while E-Zoom is being used.

## Pointer Function (Pointer)

This allows you to move a Pointer icon on the projected image, and helps you draw attention to the area you are talking about.

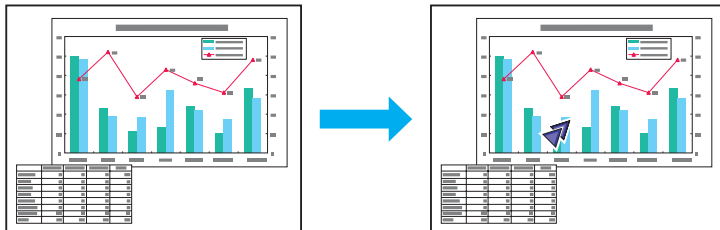

## Procedure

- 1 Display the Pointer.

### Remote Control

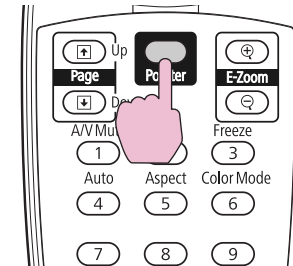

Each time you press the button, the pointer appears or disappears.

## 2 Move the Pointer icon (↗).

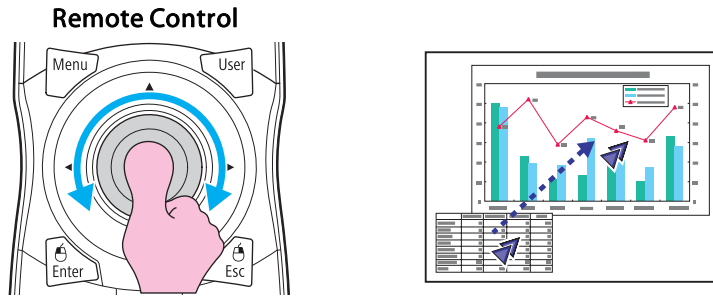

You can choose from three different kinds of Pointer icon (↗, ✕, ↘) in **Settings - Pointer Shape** from the configuration menu.  
 🖱️ p.55

## Procedure

### 1 Start E-Zoom.

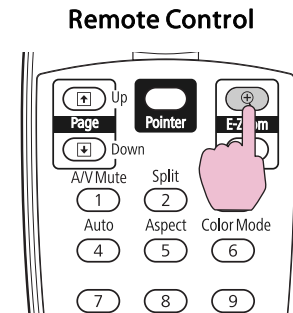

### 2 Move the (⊞) to the area of the image that you want to enlarge.

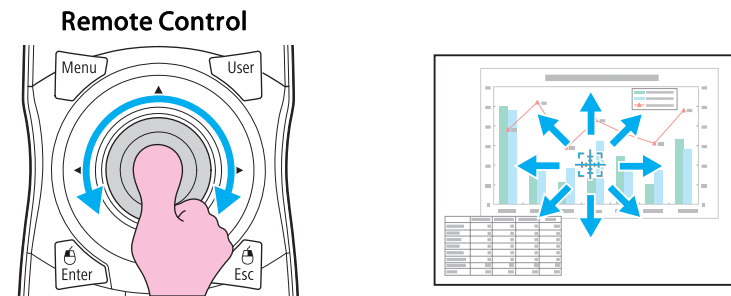

## Enlarging Part of the Image (E-Zoom)

This is useful when you want to expand images to see them in greater detail, such as graphs and tables.

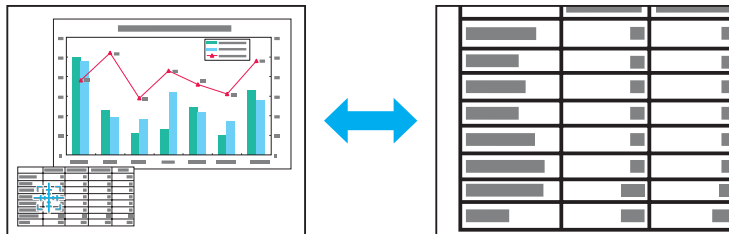

## 3 Enlarge.

### Remote Control

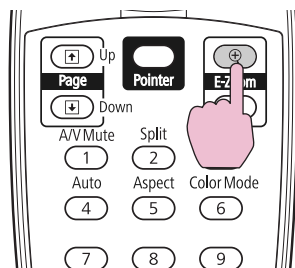

Each time the button is pressed, the area is expanded. You can expand quickly by holding the button down.

You can reduce the enlarged image by pressing the [⊖] button.

Press the [Esc] button to cancel.



- The enlargement ratio appears on the screen. The selected area can be enlarged to between 1 to 4 times in 25 incremental steps.
- After the image is enlarged, it can be scrolled with the [⊙] button.
- If E-Zoom is selected, Progressive and Noise Reduction are cancelled.
- E-Zoom is canceled when performing some functions such as Keystone or Auto Setup.

When an ID is set for the projector and the remote control, you can use the remote control to operate only the projector with a matching ID. This is very useful when managing multiple projectors.

When operating all of the projectors from the remote control, set the ID switch on the side of the remote control to Off.

- Operation using the remote control is possible only for projectors that are within the operating range of the remote control.
  - ☛ "Operating range of remote control" [p.17](#)
- When **Remote Control Type** is set to **Simple** from **Operation** in the configuration menu, you cannot set the remote control ID. [p.57](#)
- IDs are ignored when the projector ID is set to **Off** or the remote control ID is set to **0**.

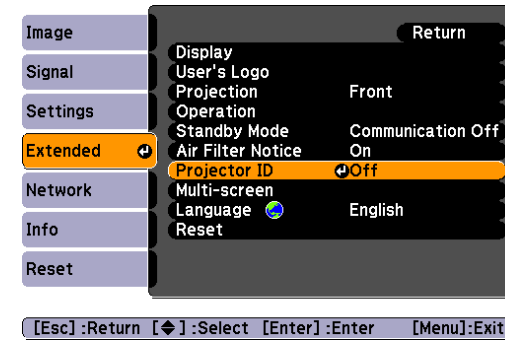

**2** Select of one of the numbers from 1 to 9 to use as the ID and then press the [Enter] button.

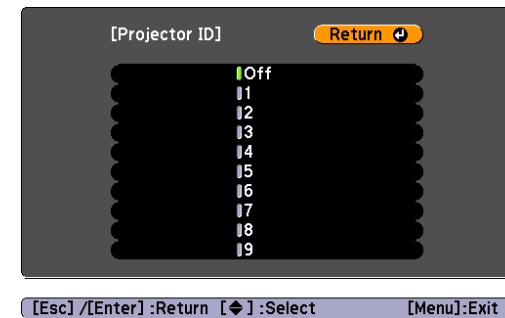

**3** Press the [Menu] button to close the configuration menu.

## Setting the Projector ID

### Procedure

**1** During projection, press the [Menu] button and select **Extended - "Projector ID"** from the configuration menu.  
 ☛ "Using the Configuration Menu" [p.50](#)

Using the Remote Control

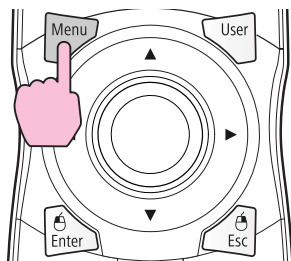

Using the Control panel

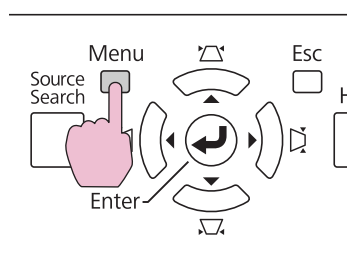

## Checking the Projector ID

Use the following procedure to check the projector ID.

## Procedure

- 1 Set the remote control ID switch to On.

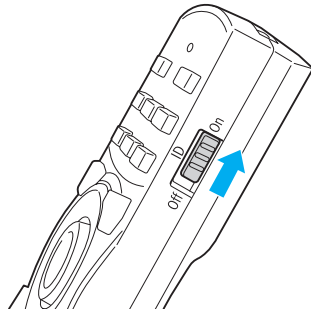

- 2 During projection, while holding the [ID] button, press the [Help] button.

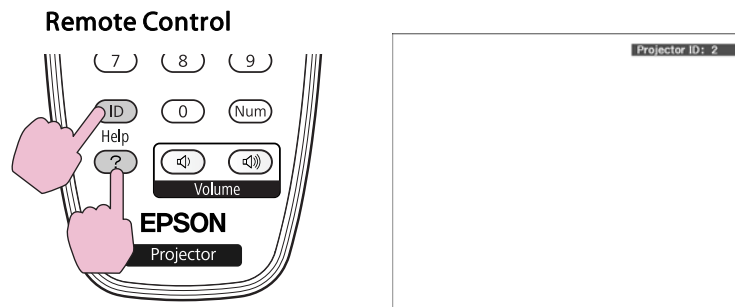

When you press the buttons, the current Projector ID is displayed on the projection screen. It disappears in about three seconds.

## Setting the Remote Control ID

### Procedure

- 1 Set the remote control ID switch to On.

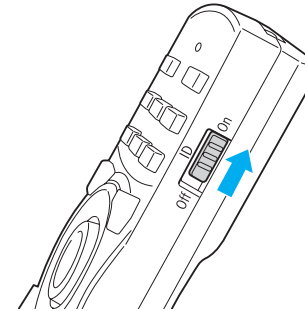

- 2 While holding the [ID] button, press a number button to select a number to match the ID of the projector you want to operate. ➡ "Checking the Projector ID" p.38

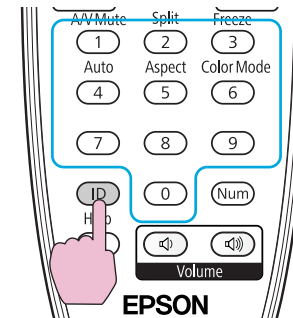

Once this setting has been made, the projector that can be operated by the remote control is limited.



The remote control ID setting is saved in the remote control. Even if the remote control batteries are removed to replace them and so on, the stored ID setting is retained. However, if the batteries are left out for a long time, it is reset to the default value (ID0).



When multiple projectors are lined up and projecting images, you can manually correct the brightness and color tone of each projector's image so that the colors projected from each projector match closely.

Use the multi-screen color adjustment function when the Color Mode of each projector is set to the same item.

In some cases the brightness and color tone may not match completely even after correction.

## Summary of Correction Procedure

When multiple projectors are set up and you need to make corrections, use the following procedure to correct one projector at a time.

1. Set the projector ID and the remote control ID.  
To limit operation to one target projector, set a Projector ID for the target projector, and set the same ID for the remote control.  p.38
2. Correct the color difference.  
You can carry out color correction when projecting from multiple projectors. You can adjust from black to white in five stages called levels 1 to 5, and in each of these 5 levels you can adjust the following two points.
  - Correcting brightness  
You can correct the image brightness to make them all equal.
  - Correcting color  
You can adjust the image color to make them match more closely by using **Color Correct. (G/R)** and **Color Correct. (B/Y)**.

## Correction Method

After setting up the projectors, correct the brightness and tone for each projector to reduce the differences.

### Procedure

- 1 Press the [Menu] button and select Extended - "Multi-screen" from the configuration menu.  "Using the Configuration Menu" p.50

Using the Remote Control

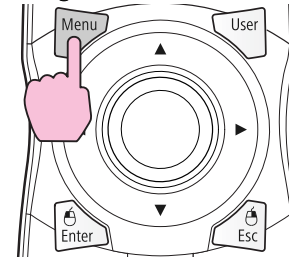

Using the Control panel

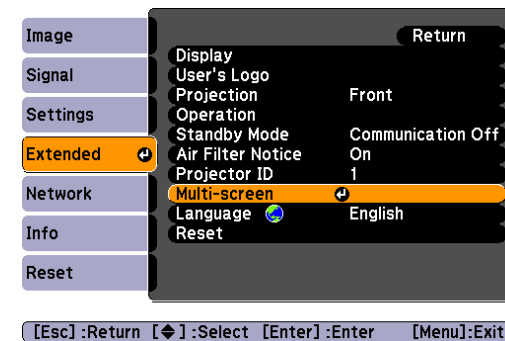
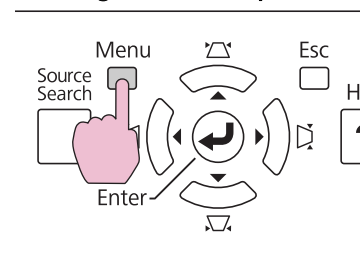

- 2 Select Lv. to be corrected in "Adjustment Level".

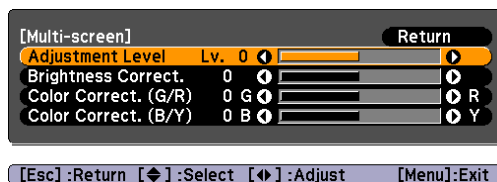

- Each time a level is selected, the pattern of the level selected is displayed.
- You can start correcting from any level, usually you can make it darker or lighter by correcting 1 to 5 or 5 to 1.

### 3 Correct the brightness with "Brightness Correct."

- When you select Lv. 5, all the images are adjusted to the darkest image from multiple projectors.
- When you select Lv. 1, all the images are adjusted to the brightest image from multiple projectors.
- When you select Lv. 2 to 4, all the images are adjusted to the mid-range brightness image from multiple projectors.
- Because each time the [Enter] button is pressed the image displayed changes between the pattern display and the actual image, you can check the correction results and make corrections in the actual image.

### 4 Correcting "Color Correct. (G/R)" and "Color Correct. (B/Y)".

Because each time the [Enter] button is pressed the image displayed changes between the pattern display and the actual image, you can check the correction results and make corrections in the actual image.

### 5 Repeat procedures 3 to 5 until corrections are finished.

### 6 When all corrections are finished, press the [Menu] button to close the configuration menu.

You can save the image that is currently being projected as a User's Logo. The saved user's logo can be used as the display image when there is no video signal input or during the A/V Mute operation.

 Once a User's Logo has been saved, the logo cannot be returned to the factory default.

## Procedure

**1** Project the image you want to use as the user's logo, and then press the [Menu] button.

Using the Remote Control

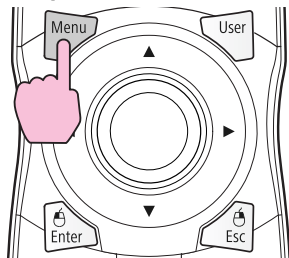

Using the Control panel

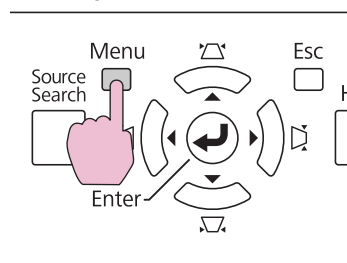

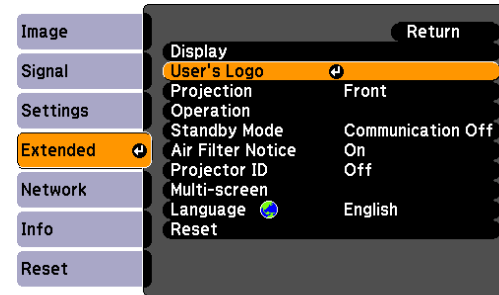

**2** Select Extended - "User's Logo" from the configuration menu.  
 "Using the Configuration Menu" [p.50](#)

Check the buttons you can use and the operations they perform in the guide under the menu.



[Esc]:Return [↕]:Select [Enter]:Enter [Menu]:Exit

 • If User's Logo Protect from Password Protect is set to On, a message is displayed and the user's logo cannot be changed. You can make changes after setting User's Logo Protect to Off.  
 [p.45](#)

• If User's Logo is selected when Keystone, E-Zoom, Aspect, or Progressive are being performed, the function currently being performed is cancelled.

**3** When "Choose this image as the User's Logo?" is displayed, select "Yes".

 When you press the [Enter] button on the remote control or the control panel, the screen size may change according to the signal as it changes to the resolution of the image signal.

- 4** Move the box to select the part of the image to use as the User's Logo.

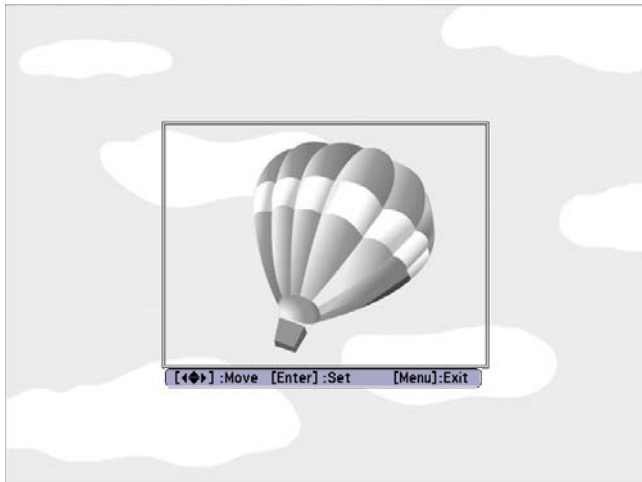

Using the Remote Control

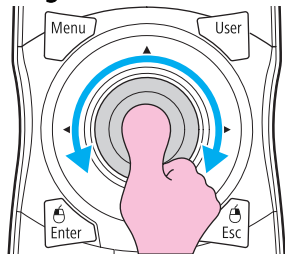

Using the Control panel

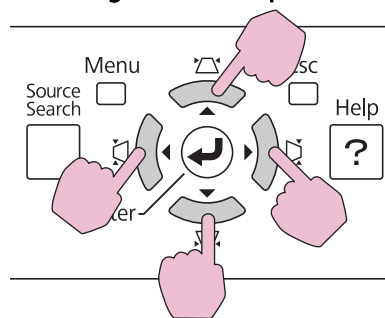

You can save at up to 400 × 300 dots in size.

- 5** When "Select this image?" is displayed, select "Yes".
- 6** Select the zoom factor from the zoom setting screen.

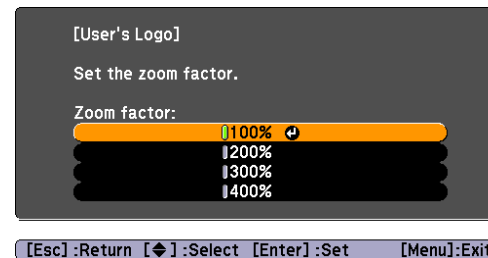



- 7** When the message "Save this image as the User's Logo?" is displayed, select "Yes".

The image is saved. After the image has been saved, the message "Completed." is displayed.



- To use the saved user's logo as the screen image, set it in the **Display** settings under the **Extended** menu. [p.57](#)
- When a User's Logo is saved, the previous User's Logo is erased.
- Saving the user's logo may take approximately 15 seconds. Do not use the projector or any connected equipment while it is saving, otherwise malfunctions may occur.

The projector has the following enhanced security functions.

- **Password Protect**  
You can limit who can use the projector.
- **Control Panel Lock**  
You can prevent people changing the settings on the projector without permission.  [p.47](#)
- **Anti-Theft Lock**  
The projector is equipped with various types of anti-theft security devices.  [p.48](#)

## 2. User's Logo Protect

Even if someone tries to change the User's Logo set by the owner of the projector, it cannot be changed. When **User's Logo Protect** is set to **On**, the following setting changes for the User's Logo are prohibited.

- Capturing a User's Logo
- Settings for **Display Background**, **Startup Screen**, and **A/V Mute** from **Display** in the configuration menu

## 3. Network Protect

When **Network Protect** is set to **On**, setting changes for **Network** menu in the configuration menu are prohibited.

## Managing Users (Password Protect)

When Password Protect is activated, people who do not know the Password cannot use the projector to project images even if the projector power is on. Furthermore, the user's logo that is displayed when you turn on the projector cannot be changed. This acts as an anti-theft device as the projector cannot be used even if it is stolen. At the time of purchase, Password Protect is not activated.

### Type of Password Protect

The following three kinds of Password Protect settings can be made according to how the projector is being used.

#### 1. Power On Protect

When **Power On Protect** is **On**, you need to enter a preset Password after the projector is plugged in and turned on (this also applies to Direct Power On). If the correct Password is not entered, projection does not start.

## Setting Password Protect

Use the following procedure to set Password Protect.

### Procedure



**During projection, hold down the [Freeze] button for about five seconds.**

The Password Protect setting menu is displayed.

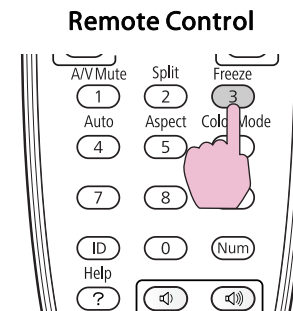



- If Password Protect is already activated, you must enter the Password.  
If the Password is entered correctly, the Password Protect setting menu is displayed. ➡ "Entering the Password" p.46
- When the Password is set, stick the Password protect sticker in a visible position on the projector as a further theft deterrent.

## 2 Turn on "Power On Protect".

- (1) Select **Power On Protect**, and then press the [Enter] button.
- (2) Select **On**, and then press the [Enter] button.
- (3) Press the [Esc] button.

## 3 Turn on "User's Logo Protect".

- (1) Select **User's Logo Protect**, and then press the [Enter] button.
- (2) Select **On**, and then press the [Enter] button.
- (3) Press the [Esc] button.

## 4 Turn on "Network Protect".

- (1) Select **Network Protect**, and then press the [Enter] button.
- (2) Select **On**, and then press the [Enter] button.
- (3) Press the [Esc] button.

## 5 Set the Password.

- (1) Select **Password**, and then press the [Enter] button.
- (2) The message "Change the password?" is displayed, select **Yes** and then press the [Enter] button. The default setting for the Password is "0000". Change this to your own desired password. If you select **No**, the screen shown in step 1 is displayed again.
- (3) While holding down the [Num] button, enter a four digit number using the numeric buttons. The number entered is displayed as "\* \* \* \*". When you enter the fourth digit, the confirmation screen is displayed.

### Remote Control

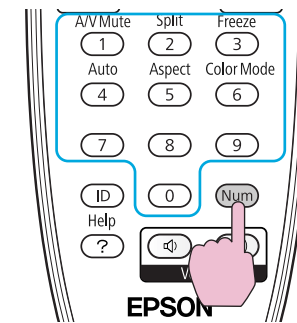

- (4) Re-enter the Password.  
The message "Password accepted." is displayed.  
If you enter the Password incorrectly, a message is displayed prompting you to re-enter the password.

### Entering the Password

When the Password entry screen is displayed, enter the Password using the numeric buttons on the remote control.

#### Procedure

**While holding down the [Num] button, enter the Password by pressing the numeric buttons.**

When you enter the correct Password, projection begins.

## Attention

- If an incorrect password is entered three times in succession, the message "The projector's operation will be locked." is displayed for about five minutes, and then the projector switches to standby mode. If this happens, disconnect the power plug from the electrical outlet and then reinsert it and turn the projector's power back on. The projector displays the Password entry screen again so that you can enter the correct Password.
- If you have forgotten the password, make a note of the "Request Code: xxxxx" number that appears on the screen and contact the nearest address provided in the Support and Service Guide. [Epson Projector Contact List](#)
- If you continue to repeat the above operation and input the wrong Password thirty times in succession, the following message is displayed and the projector does not accept any more Password entries. "The projector's operation will be locked." Contact Epson as described in your documentation. [Epson Projector Contact List](#)

## Restricting Operation (Control Panel Lock)

Perform one of the following to lock the operation buttons on the control panel. Even if the control panel is locked, you can still use the remote control as usual.

- **Full Lock**  
All of the buttons on the control panel are locked. You cannot perform any operations from the control panel, including turning the power on or off.
- **Partial Lock**  
All of the buttons on the control panel, except for the [⏻] button, are locked.

1

During projection, press the [Menu] button and select Settings - Control Panel Lock from the configuration menu. ["Using the Configuration Menu" p.50](#)

Using the Remote Control

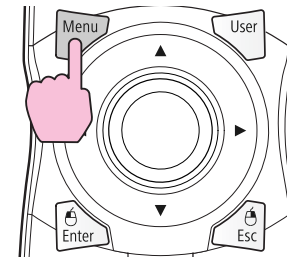

Using the Control panel

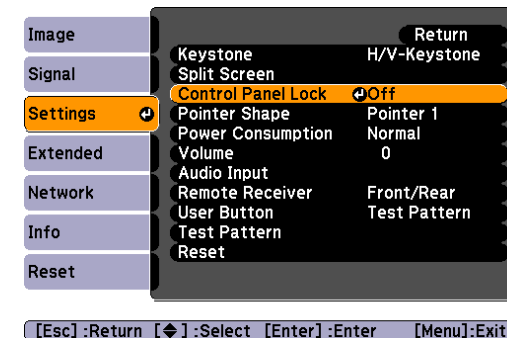
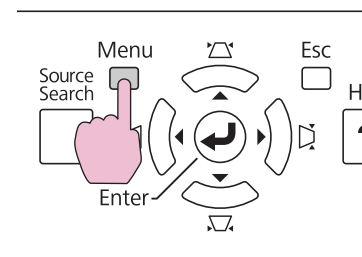

2

Select either Full Lock or Partial Lock according to your purpose.

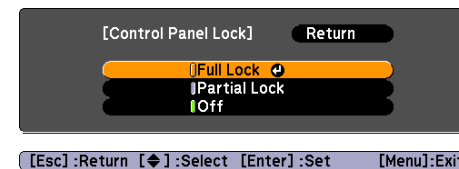

3

Select Yes when the confirmation message is displayed.

The control panel buttons are locked according to the setting you chose.



You can release the control panel lock by one of the following two methods.

- From the remote control, select **Off** in **Settings - Control Panel Lock** from the configuration menu. 🖱️ p.55
- Hold down the [Enter] button on the Control panel for about seven seconds, a message is displayed and the lock is released.

## Anti-Theft Lock

As the projector is often setup on ceiling mounts and left in rooms unattended, the projector includes the following security devices to prevent someone from taking the projector.

- Security slot  
The Security slot is compatible with the Microsaver Security System manufactured by Kensington. You can find details about the Microsaver Security System on the Kensington homepage <http://www.kensington.com/>.
- Security cable installation point  
A commercially available anti-theft wire lock can be passed through the security cable installation point to secure the projector to a desk or pillar.
- Screw to fix the lens unit removal button  
The lens removal button can be locked with the screw supplied so that the projection lens cannot be removed immediately.

### Installing the wire lock

Pass an anti-theft wire lock through the security cable installation point. See the documentation supplied with the wire lock for locking instructions.

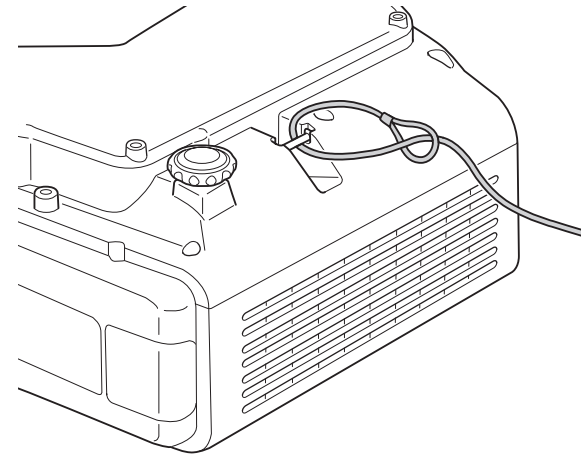

### Anti-theft projection lens

The bayonet type allows you to simply and easily exchange the projector's lens. If you are concerned about security, this is a useful anti-theft device as, once it is locked with the screw supplied, it cannot be quickly removed.

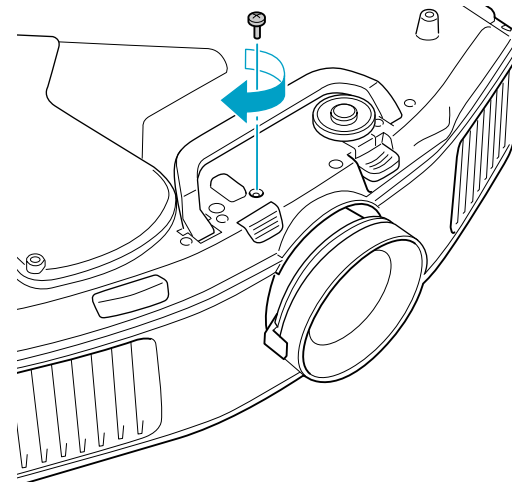





# Configuration Menu

This chapter explains how to use the configuration menu and its functions.

## 1 Selecting from the top menu

## 2 Selecting from the sub menu

## 3 Setting Each Item

## 4 Exit

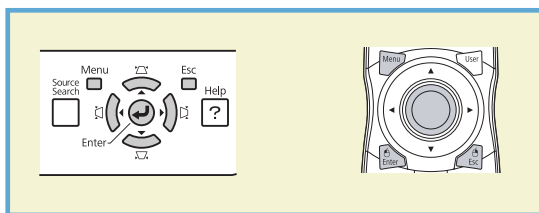
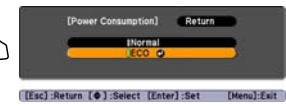
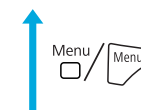
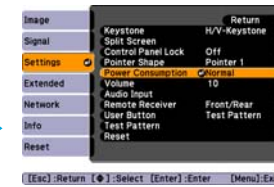
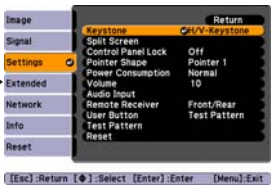
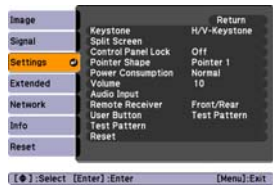
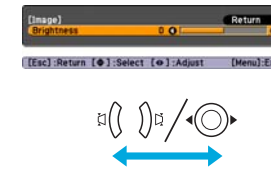
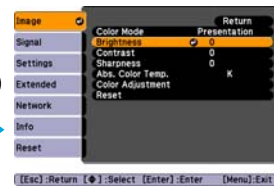
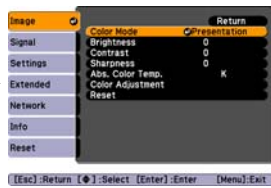
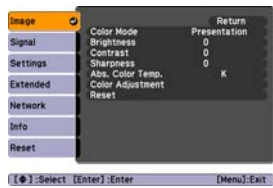

Items that can be set vary depending on the image signal or input source currently being projected as shown in the following screen shots. Setting details are saved for each image signal.

## RGB Signal/USB/LAN

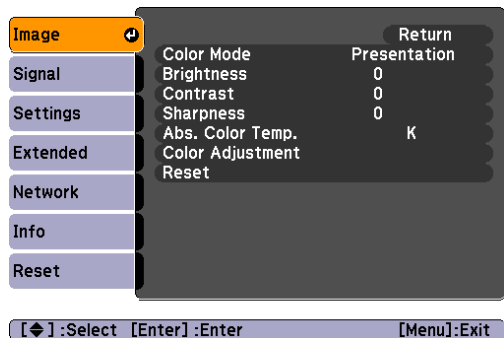

## Component Video Signal▶/ Composite video Signal▶/S-Video Signal▶

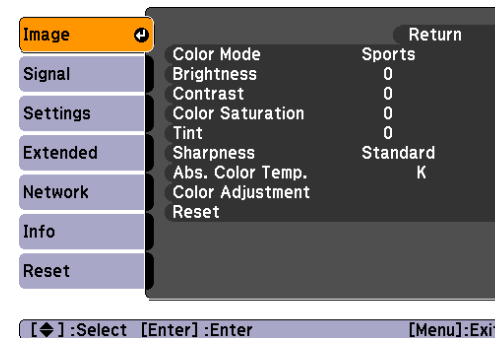

Sub Menu	Function
<b>Color Mode</b>	You can select the quality of the image to suit your surroundings. 🖱️ <a href="#">p.29</a>
<b>Brightness</b>	You can adjust the image Brightness.
<b>Contrast▶▶</b>	You can adjust the difference between light and shade in the images.
<b>Color Saturation</b>	You can adjust the Color Saturation for the images.
<b>Tint*1</b>	You can adjust the image Tint.
<b>Sharpness</b>	<p><b>Standard:</b> You can adjust the image sharpness. To make more-detailed settings, select <b>Advanced</b>.</p> <p><b>Advanced*2:</b> The following four items can be set.</p> <p><b>Thin Line Enhancement:</b> If this parameter is set to a positive value, details such as hair or fabric patterns will be enhanced.</p> <p><b>Thick Line Enhancement:</b> If this parameter is set to a positive value, the outline, background, and the other main parts of the objects in the image will be enhanced to show them clearly.</p> <p><b>Vert. Line Enhancement:</b> If this parameter is set to a positive value, vertical lines in the image are enhanced.</p> <p><b>Horiz. Line Enhancement:</b> If this parameter is set to a positive value, horizontal lines in the image are enhanced.</p>
<b>Abs. Color Temp.*3</b>	You can adjust the overall tint of the image in 10 stages from 5000 K to 10000 K. When a high value is selected the image becomes tinged with blue, when a low value is selected the image becomes tinged with red.

Sub Menu	Function
<b>Color Adjustment</b>	You can make adjustments by choosing one of the following. <b>Red, Green, Blue</b> *4: You can adjust the saturation of each color individually. <b>R, G, B, C, M, Y</b> : You can adjust the hue, saturation, and brightness of each color R (red), G (green), B (blue), C (cyan), M (magenta), Y (yellow) individually. (This item can be set simply by setting the <b>Color Mode</b> to <b>Customized</b> .)
<b>Reset</b>	You can reset all adjustment values for the <b>Image</b> menu functions to their default settings. To return all menu items to their default settings, see  <a href="#">p.76</a>

\*1 This parameter can be set for composite video signal input or S-video signal input only when inputting a NTSC-system signal.

\*2 This parameter cannot be set for RGB signal input or when the input source is set to **USB** or **LAN**.

\*3 This parameter cannot be set when the Color Mode is set to **sRGB**.

\*4 This parameter cannot be set when the Color Mode is set to **sRGB** or **Customized**.

Items that can be set vary depending on the image signal or input source currently being projected as shown in the following screen shots. Setting details are saved for each image signal.

You cannot make settings in the Signal menu when the input source is USB or LAN.

## RGB Signal

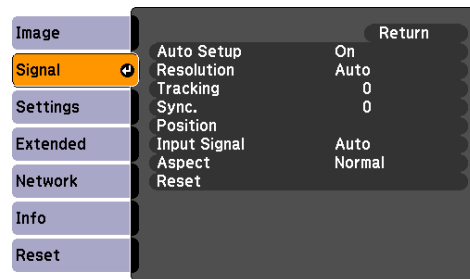

[Left Arrow]:Select [Enter]:Enter [Menu]:Exit

## Component Video Signal

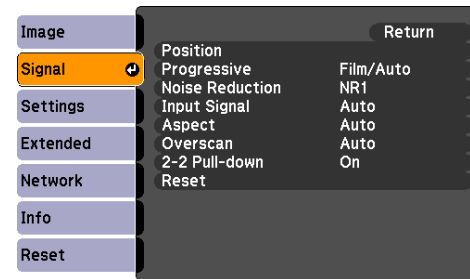

[Left Arrow]:Select [Enter]:Enter [Menu]:Exit

## Composite video Signal/S-Video Signal

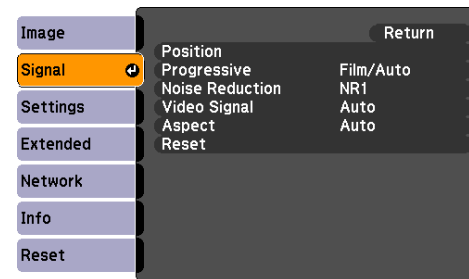

[Left Arrow]:Select [Enter]:Enter [Menu]:Exit

## DVI-D/HDMI

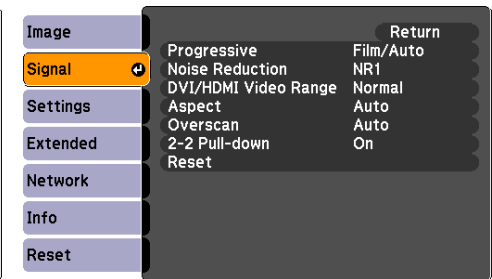

[Left Arrow]:Select [Enter]:Enter [Menu]:Exit

Sub Menu	Function
<b>Auto Setup</b>	You can select whether or not ( <b>On/Off</b> ) Auto Setup automatically adjusts the image to the optimum state when the Input Signal changes.
<b>Resolution</b>	<p><b>Auto:</b> The resolution of the input signal is automatically identified.</p> <p><b>Wide, Normal:</b> If the images cannot be projected correctly when <b>Auto</b> is set, set this menu. Set to <b>Wide</b> depending on the connected computer for wide screens, or set to <b>Normal</b> for 4:3 or 5:4 screens.</p> <p><b>Manual:</b> You can specify the resolution. This is ideal when connected computer is fixed.</p>
<b>Tracking</b>	You can adjust computer images when vertical stripes appear in the images.
<b>Sync.</b>	You can adjust computer images when flickering, fuzziness, or interference appear in the images.
<b>Position</b>	You can adjust the display Position up, down, left, and right when a part of the image is missing so that the whole image is projected.
<b>Progressive*1*2*4</b>	<p><b>Off:</b> IP conversion is carried out for each field in the screen. This is ideal for viewing images with a large amount of movement.</p> <p><b>Video:</b> This is ideal for viewing general video images.</p> <p><b>Film/Auto:</b> By automatically converting movie films, CG, animated images, and so on recorded in 24/30 frames to the optimum progressive signal via 2-3 pull-down, it is possible to recreate the natural feel of the original image.</p>
<b>Noise Reduction*2</b>	Smoothes out rough images. There are two modes. Select your favorite setting. It is recommended that this is set to <b>Off</b> when viewing image sources in which noise is very low, such as for DVDs.

Sub Menu	Function
<b>DVI/HDMI Video Range</b>	When the DVI-D or the HDMI input port are connected to a DVD player, set the video level according to the video level setting of the DVD player. When <b>HDMI</b> is selected for the input source and the range is set to <b>Auto</b> * <sup>3</sup> , the video level of the input signal will be automatically determined. If the range is set to <b>Auto</b> and the image shows whiteout or blackout, set the video level according to the video level setting of the DVD player. The video level of the DVD player may be set to Normal or Expanded.
<b>Input Signal</b>	You can select the input signal from the Computer1 input port or BNC input port. If <b>Auto</b> is set, the input signal is identified automatically according to the connected equipment. If colors do not appear correctly when this is set to <b>Auto</b> , select the appropriate signal according to the connected equipment.
<b>Video Signal</b>	You can select the input signal from the Video1 input port, Video2 input port, and S-Video input port. If set to <b>Auto</b> , video signals are recognized automatically. If interference appears in the image or a problem occurs such as no image is being projected when set to <b>Auto</b> , select the appropriate signal according to the connected equipment.
<b>Aspect</b>	You can set the <u>Aspect Ratio</u> ▶▶ for projected images. 🖱️ <a href="#">p.27</a>
<b>Overscan</b> * <sup>2</sup>	You can change the Output Scaling (the range of projected image). The range of trimming screen can be set to <b>Off</b> , <b>4%</b> , or <b>8%</b> . You can select <b>Auto</b> * <sup>3</sup> only when the input source is <b>HDMI</b> . When <b>Auto</b> is selected, the range is automatically switched to <b>Off</b> or <b>8%</b> according to the input signal.
<b>2-2 Pull-down</b> * <sup>2</sup>	This can be set only when 1080p/24Hz signals are being input. If this is set to <b>On</b> , images recorded 24 frames per second such as movies are projected by original frame rate without frame interpolation. It is possible to recreate the natural feel of the original image.
<b>Reset</b>	You can reset all adjustment values on the <b>Signal</b> menu to their default settings, except for <b>Input Signal</b> . To return all menu items to their default settings, see 🖱️ <a href="#">p.76</a>







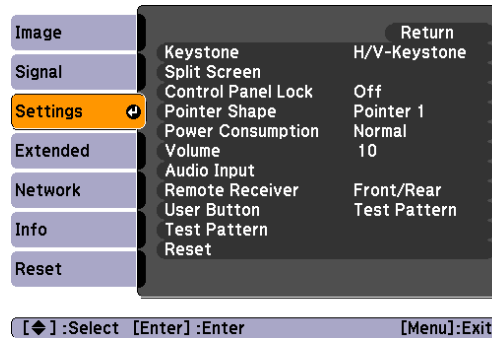

\*1 When a component video or RGB video signals are input, this setting can be set only when 480i, 576i, or 1080i signals are being input.



\*2 This cannot be set when a digital RGB signal is input.

\*3 This can be set only when the HDMI output on the connected equipment is connected to the HDMI input port on the projector.

\*4 This cannot be set when inputting 1080i signal and the aspect mode is set to **Full**.





Sub Menu	Function
<b>Keystone</b>	<p>You can correct keystone distortion.</p> <p><b>H/V-Keystone:</b> Corrects horizontal and vertical keystone distortion. Select one of <b>V-Keystone</b> or <b>H-Keystone</b>.  p.23</p> <p>Use the [↖/↗], [↘/↙], [↵/↔] and [↔/↵] buttons on the control panel to perform similar corrections to <b>V-Keystone</b> and <b>H-Keystone</b>.</p> <p><b>Quick Corner:</b> Selects and corrects the four corners of the projected image.  p.21</p>
<b>Split Screen</b>	You can split the screen into two screens.  p.30
<b>Control Panel Lock</b>	You can use this to restrict operation of the projector's control panel.  p.47
<b>Pointer Shape</b>	<p>You can select the shape of the pointer.  p.35</p> <p><b>Pointer 1:</b>  <b>Pointer 2:</b>  <b>Pointer 3:</b> </p>
<b>Power Consumption</b>	<p>You can set the lamp brightness to <b>Normal</b> or <b>ECO</b>.</p> <p>Select <b>ECO</b> if the images being projected are too bright such as when projecting images in a dark room or onto a small screen. When <b>ECO</b> is selected, the amount of electricity consumed and the lamp's operating life are changed as follows, and the fan rotation noise during projection is reduced. Electrical consumption: about 16% decrease, lamp life: about 1.5 times longer</p>
<b>Volume</b>	You can adjust the volume. Setting details are saved for each source and each image signal.
<b>Audio Input</b>	<b>LAN Audio Input:</b> When the image from a computer that is connected through the network is being projected, audio is output from the projector using the port that is set here. When transferring audio from the computer to the projector to output it, select <b>LAN</b> .
<b>Remote Receiver</b>	<p>You can limit the reception of the operation signal from the remote control.</p> <p>When you want to prohibit operation by remote control, or if the remote receiver has a fluorescent light too close to it, you can make settings to deactivate the remote receiver you do not want to use or that is experiencing interference.</p> <p>If the [Menu] button on the remote control or control panel is pressed for 15 seconds, this parameter will return to the default setting.</p>

Sub Menu	Function
<b>User Button</b>	You can select the item assigned from the configuration menu with the remote control's [User] button. By pressing the [User] button the assigned menu item selection/adjustment screen is displayed, allowing you to make one-touch settings/adjustments. You can assign one of the following six items to the [User] button. <b>Power Consumption, Info, Progressive, Test Pattern, Multi-screen, and Resolution</b>
<b>Test Pattern</b>	When the projector is setup, a Test Pattern is displayed so that you can adjust the projection without connecting other equipment.  <a href="#">p.19</a>
<b>Reset</b>	You can reset all adjustment values on the <b>Settings</b> menu to their default settings, except for <b>User Button</b> . To return all menu items to their default settings, see  <a href="#">p.76</a>

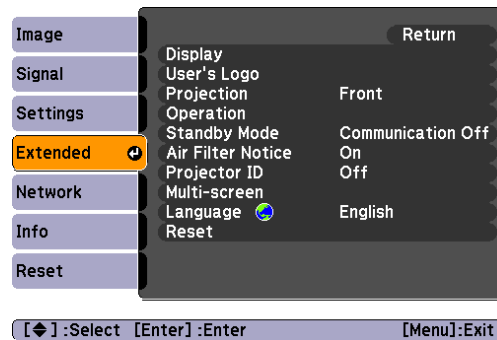



Sub Menu	Function
<b>Display</b>	<p>You can make settings related to the projector's display.</p> <p><b>Messages:</b> The following messages are not displayed on the screen when this item is set to <b>Off</b>. Overheating and other warnings, messages such as when there is no video input, and when Freeze is On or when changing Source, Color Mode or Aspect.</p> <p><b>Display Background*1:</b> You can set the screen status for when no image signal is available to <b>Black, Blue, or Logo</b>.</p> <p><b>Startup Screen*1:</b> Set this parameter to <b>On</b> to display the user's logo when projection is started.</p> <p><b>A/V Mute*1:</b> You can set the screen displayed during A/V Mute as <b>Black, Blue, or Logo</b>.</p> <p><b>Menu Size:</b> You can select <b>Normal</b> or <b>Larger</b> for the display size of the configuration menu, Help, and other messages.</p>
<b>User's Logo*1</b>	<p>You can change the User's Logo that is displayed as a background during Display Background or Startup Screen. 🖱️ <a href="#">p.43</a></p>
<b>Projection</b>	<p>Set this parameter according to the installation status of the projector. 🖱️ <a href="#">p.124</a></p>

Sub Menu	Function
<b>Operation</b>	<p><b>Direct Power On:</b> You can set whether or not (<b>On/Off</b>) to enable Direct Power On. Be careful when this item is set to <b>On</b> because this unit turns on at the time of power recovery with this unit plugged-in to an outlet.</p> <p><b>Sleep Mode:</b> When set to <b>On</b>, this automatically stops projection when no image signal is being input and no operations are carried out.</p> <p><b>Sleep Mode Timer:</b> When <b>Sleep Mode</b> is set to <b>On</b>, you can set the time before the projector automatically turns off within a range of 1 to 30 minutes.</p> <p><b>High Altitude Mode:</b> Set to <b>On</b> when using the projector above an altitude of 1500 m.</p> <p><b>BNC Sync Termination:</b> Set the termination for the signal from the BNC input port. This should usually be set to <b>Off</b>. Set to <b>On</b> when analog (75Ω) termination such as for switchers is necessary.</p> <p><b>Remote Control Type:</b> You can select <b>Normal</b> or <b>Simple</b> depending on the type of remote control. Set this item to <b>Normal</b> to use the remote control provided with the projector. When <b>Simple</b> is selected, you can use the remote control provided with other Epson projectors to operate this projector. This is useful if you want to use a remote control that you are already familiar with to operate the projector. (When using the remote control that is supplied with an EB-G5xxx-series or EB-Z80xx-series projector, select <b>Normal</b>.)</p> <p>However, you cannot use the remote control provided with this projector if this is set to <b>Simple</b>. Make sure that the setting is correct because, if the projector is mounted on the ceiling or somewhere hard to reach, changing it back to <b>Normal</b> may be difficult. Additionally, you cannot use the functions that are not equipped with this projector or the remote control which you use.</p> <p><b>Inv Direction Button:</b> Set this to <b>On</b> when suspending the projector from the ceiling.  <a href="#">p.124</a></p>
<b>Standby Mode</b>	<p>You can use the functions that monitor and control the status of the projector over the network even when the projector is in standby mode if this is set to <b>Communication On</b>.</p>
<b>Air Filter Notice</b>	<p>You can set whether or not (<b>On/Off</b>) to enable Air Filter Notice. When this is set to <b>On</b> and a clog in the air filter is detected, the message is displayed on the screen.</p>
<b>Projector ID</b>	<p>Set the ID within a range of 1 to 9. <b>Off</b> indicates that no ID is set.  <a href="#">p.38</a></p>
<b>Multi-screen</b>	<p>You can adjust the hue and brightness of each projected image when two or more projectors are lined up and projecting.  <a href="#">p.41</a></p> <p><b>Adjustment Level:</b> You can adjust from black to white in five stages called Level 1 to 5, and in each of these 5 levels you can adjust Brightness Correct. and Color Correct.</p> <p><b>Brightness Correct.:</b> Corrects the difference in the brightness of each projector.</p> <p><b>Color Correct. (G/R) / Color Correct. (B/Y):</b> You can correct the difference in the color of each projector.</p>
<b>Language</b>	<p>You can set the Language for message displays.</p>



Sub Menu	Function
<b>Reset</b>	You can reset <b>Display</b> <sup>*2</sup> , <b>Operation</b> <sup>*3</sup> , and <b>Air Filter Notice</b> from the <b>Extended</b> menu to their default settings. To return all menu items to their default settings, see  <a href="#">p.76</a>

\*1 When **User's Logo Protect** is set to **On** in Password Protect, settings relating to the user's logo cannot be changed. You can make changes after setting **User's Logo Protect** to **Off**.  [p.43](#)

\*2 Except for parameters related to the user's logo.

\*3 Except for the **Inv Direction Button**, **High Altitude Mode**, and **Remote Control Type** parameters.

When **Network Protect** is set to **On** in **Password Protect**, a message is displayed and the settings cannot be changed. You can make changes after setting **Network Protect** to **Off**.  [p.45](#)

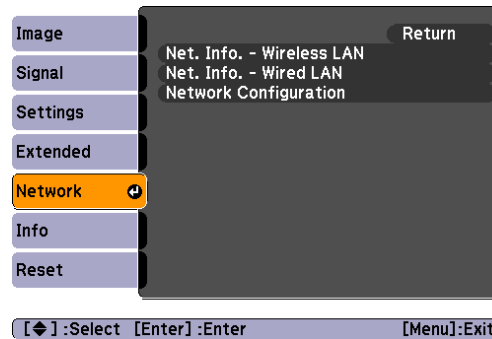

Sub Menu	Function
Net. Info. - Wireless LAN Net. Info. - Wired LAN	Displays the network settings.
Network Configuration	Displays the screen to set the network.  <a href="#">p.61</a>



By using the Web browser of a computer connected to the projector on a network, you can set the projector's functions and control the projector. This function is called "Web Control". You can easily enter text using a keyboard to make settings for "Web Control" such as security settings.  [p.105](#)

## Notes on Operating the Network Menu

Selecting from the top menu and sub menus, and changing of selected items are the same as operations in the configuration menu.

When done, make sure you go to the **Setup complete**, and select one of **Yes**, **No**, or **Cancel**. When you select **Yes** or **No**, you return to the configuration menu.



- Yes:** Saves the settings and exits the **Network** menu.
- No:** Exits to the **Network** menu without saving the settings.
- Cancel:** Continues displaying the **Network** menu.

## Soft Keyboard Operations



The **Network** menu contains items that require input of alphanumerics during setup. In this case, the following software keyboard is displayed. Use the [◊] button on the remote control or [△/▲], [▽/▼], [◂/◄] and [▸/►] buttons on the control panel to move the cursor to the desired key, and then press the [Enter] button to enter the alphanumeric. Enter figures by holding down the [Num] button on the remote control, and pressing the numeric buttons. After inputting, press [Finish] on the keyboard to confirm your input. Press [Cancel] on the keyboard to cancel your input.

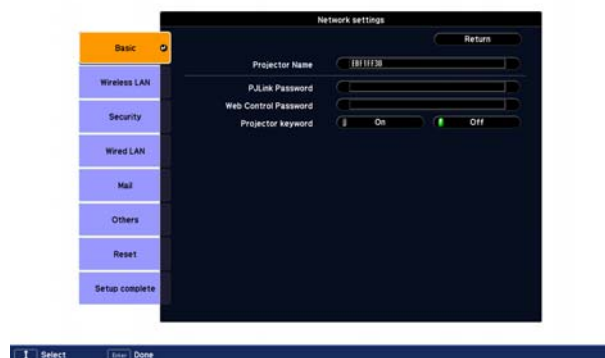

- Each time the [CAPS] key is selected and the [Enter] button is pressed, it switches between uppercase and lowercase letters.
- Each time the [SYM1/2] key is selected and the [Enter] button is pressed, it switches the symbol keys in the section enclosed in the box.

## Basic Menu



Sub Menu	Function
<b>Projector Name</b>	Displays the projector name used to identify the projector when connected to a network. When editing, you can enter up to 16 single-byte alphanumeric characters.
<b>PJLink Password</b>	Set a password to use when you access the projector using compatible PJLink software.  <a href="#">p.111</a> You can enter up to 32 single-byte alphanumeric characters.
<b>Web Control Password</b>	Set a password to use when making settings and controlling the projector using Web Control. You can enter up to 8 single-byte alphanumeric characters. Web Control is a computer function that allows you to set up and control the projector by using the Web browser on a computer connected on a network.  <a href="#">p.105</a>
<b>Projector Keyword</b>	When set to <b>On</b> , you have to enter the keyword when you try to connect the projector to a computer on a network. As a result, you can prevent presentations from being interrupted by unscheduled connections from the computer. Normally this should be set to <b>On</b> .

## Wireless LAN Menu

To connect the projector to a computer using a wireless LAN, install the Wireless LAN unit (ELPAP03).  [p.134](#)



Sub Menu	Function
<b>Wireless LAN Power</b>	Set this parameter to <b>On</b> when connecting the projector and a computer via a wireless LAN. If you do not want to connect via a wireless LAN, set this parameter to <b>Off</b> to prevent unauthorized access by others.
<b>Connection Mode</b>	Set the connection mode to use when connecting the projector and a computer via a wireless LAN. When using an <b>AdHoc</b> connection, the connection mode is set to <b>Quick</b> . When using <b>Infrastructure Mode</b> , the connection mode is set to <b>Advanced</b> . When connecting the computer to the projector using EasyMP Multi PC Projection, set the connection mode to <b>Advanced</b> .
<b>Wi-Fi Protected Setup</b>	When using a <b>WPS (Wi-Fi Protected Setup)</b> compatible access point via a wireless LAN, you can easily connect the projector to the access point and make security settings.  <a href="#">p.118</a>
<b>Channel</b>	When connecting in Quick mode, you can select a channel that uses 802.11b/g. If interference from other signals occurs, use a different channel.
<b>Wireless LAN system</b>	Sets the wireless LAN system. When connecting in Advanced mode, <b>Auto</b> can be set to automatically select a method that is suitable to the application environment. In an area that does not support 802.11a, only <b>802.11b/g</b> is displayed.
<b>SSID Auto Setting</b>	When connecting in Quick mode, SSID Auto Setting can be set to <b>On</b> to enable finding this projector faster from among multiple projectors to make connection more stable. The SSID will be created automatically, so the following address cannot be set. Set this parameter to <b>Off</b> when connecting from one computer to multiple projectors.
<b>SSID</b>	Enter an SSID. When an SSID is provided for the wireless LAN system in which the projector participates, enter the SSID. You can enter up to 32 single-byte alphanumeric characters.



Sub Menu	Function
<b>DHCP</b>	You can set whether or not ( <b>On/Off</b> ) to use <a href="#">DHCP</a> . If this is set to <b>On</b> you cannot set any more addresses.
<b>IP Address</b>	You can input the <a href="#">IP address</a> assigned to the projector. You can input a number from 0 to 255 in each field of the address. However, the following IP addresses cannot be used. 0.0.0.0, 127.x.x.x, 224.0.0.0 to 255.255.255.255 (where x is a number from 0 to 255)
<b>Subnet Mask</b>	You can input the <a href="#">Subnet Mask</a> for the projector. You can input a number from 0 to 255 in each field of the address. However, the following subnet masks cannot be used. 0.0.0.0, 255.255.255.255
<b>Gateway Address</b>	You can input the IP address for the gateway for the projector. You can input a number from 0 to 255 in each field of the address. However, the following <a href="#">Gateway addresses</a> cannot be used. 0.0.0.0, 127.x.x.x, 224.0.0.0 to 255.255.255.255 (where x is a number from 0 to 255)
<b>MAC Address</b>	Displays the MAC address.
<b>SSID Display</b>	To prevent the SSID from being displayed on the LAN Standby screen, set this to <b>Off</b> .
<b>IP Address Display</b>	To prevent the IP address from being displayed on the LAN Standby screen, set this to <b>Off</b> .



## Security Menu (Only available when the Wireless LAN unit is installed)

When the Wireless LAN unit is installed and being used in Advanced mode, it is strongly recommended that you set security.

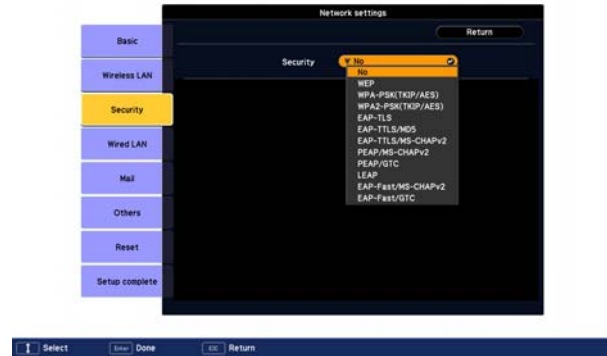

Sub Menu	Function
<p><b>Security</b></p>	<p>You can select one type of security.</p> <p>When setting up security, follow the instructions from the administrator of the network system you are about to access.</p> <p>The following types of security are provided by the projector.</p> <p><b>WEP:</b> Data is encrypted with a code key (WEP key)</p> <p>This mechanism prevents communication unless the encrypted keys for the access point and the projector match.</p> <p><b>WPA/WPA2:</b> This is an encryption standard that improves security which is a weak point of WEP. Although there are multiple kinds of WPA encryption methods, this projector uses "TKIP" and "AES".</p> <p>WPA also includes user authentication functions. WPA authentication provides two methods: using an authentication server, or authenticating between a computer and an access point without a server. This projector supports the latter method, without a server.</p> <p><b>EAP:</b> EAP is a protocol used for communication between clients and authentication servers. These are multiple protocols, such as EAP-TLS which uses electronic certification for user authentication, LEAP which uses user name and password, and EAP-TTLS.</p>



If using EAP, you need to make settings at the projector that match the authentication server settings. Check with your network administrator for details on RADIUS settings.

## When WEP is selected





Sub Menu	Function
<b>WEP Encryption</b>	You can set the encryption for WEP encoding. <b>128 Bit:</b> Uses 128 (104) bit encoding <b>64 Bit:</b> Uses 64 (40) bit encoding
<b>Format</b>	You can set the input method for the WEP encrypted key. <b>ASCII:</b> Input text. The method of inputting the encrypted WEP with text differs depending on the access point. Check with the network administrator for the network in which the projector participates, and then set to "ASCII". <b>HEX:</b> Input in hexadecimal.
<b>Key ID</b>	Selects the WEP encryption ID key.
<b>Encryption Key 1/Encryption Key 2/Encryption Key 3/Encryption Key 4</b>	You can enter the key used for WEP encryption. Enter the key in single-byte characters following instructions from the network administrator for the network in which the projector participates. The type of character and the number that can be entered differ according to the <b>WEP Encryption</b> and <b>Format</b> settings. If the number of characters you enter is shorter than the required character length, no character is encrypted. If the number of characters you enter is longer than the required character length, characters that exceed the permitted number are not encrypted. <b>128 Bit - ASCII:</b> Single-byte alphanumerics, 13 characters. <b>64 Bit - ASCII:</b> Single-byte alphanumerics, 5 characters. <b>128 Bit - HEX:</b> 0 to 9 and A to F, 26 characters <b>64 Bit - HEX:</b> 0 to 9 and A to F, 10 characters

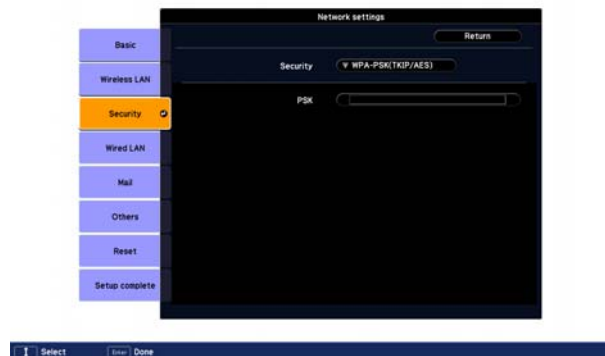

Sub Menu	Function
<b>Authentication Type</b>	You can set Authentication Type for WEP encoding. <b>Open:</b> Method to connect access point with no authentication. <b>Shared:</b> Authentication Type using WEP key.

**When WPA-PSK(TKIP/AES) or WPA2-PSK(TKIP/AES) is selected**



Sub Menu	Function
<p><b>PSK (Encryption key)</b></p>	<p>You can enter a Pre-Shared Key (encrypted key) in single-byte alphanumeric characters. Enter at least 8 and up to 63 characters. When the Pre-Shared Key is entered and the [Enter] button is pressed, the value is set and displayed as an asterisk (*).                      You cannot enter more than 32 characters on the configuration menu. When setting from Web Control, you can enter more than 32 characters.</p> <p> <a href="#">p.105</a></p>

**When EAP-TLS is selected**



Refer to the following information to register a digital certificate to the projector for authentication. [PC Free Operation Guide "Registering a Digital Certificate to the Projector"](#)

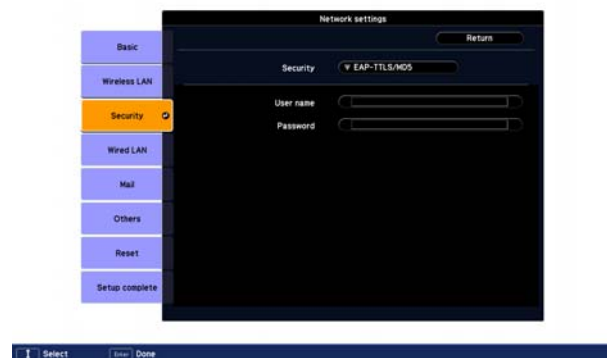

Sub Menu	Function
Issued to/Issued by/Validity period	Information in the certificate is displayed. You cannot enter.

EAP-TTLS/MD5, EAP-TTLS/MS-CHAPv2, PEAP/MS-CHAPv2, PEAP/GTC, LEAP, EAP-Fast/MS-CHAPv2, EAP-Fast/GTC is selected



Sub Menu	Function
<b>User name</b>	You can enter a user name to be used for authentication in single-byte alphanumeric characters (no spaces). You can enter up to 64 characters. You cannot enter more than 32 characters on the configuration menu. When setting from Web Control, you can enter more than 32 characters.  <a href="#">p.105</a>
<b>Password</b>	You can enter an authentication password in single-byte alphanumeric characters. You can enter up to 64 characters. When the password is entered and the [Enter] button is pressed, the value is set and displayed as an asterisk (*). You cannot enter more than 32 characters on the configuration menu. When setting from Web Control, you can enter more than 32 characters.  <a href="#">p.105</a>

## Wired LAN Menu



Sub Menu	Function
DHCP	You can set whether or not ( <b>On/Off</b> ) to use <u>DHCP</u> ▶▶. If this is set to <b>On</b> you cannot set any more addresses.
IP Address	You can input the <u>IP address</u> ▶▶ assigned to the projector. You can input a number from 0 to 255 in each field of the address. However, the following IP addresses cannot be used. 0.0.0.0, 127.x.x.x, 224.0.0.0 to 255.255.255.255 (where x is a number from 0 to 255)
Subnet Mask	You can input the <u>Subnet Mask</u> ▶▶ for the projector. You can input a number from 0 to 255 in each field of the address. However, the following subnet masks cannot be used. 0.0.0.0, 255.255.255.255
Gateway Address	You can input the IP address for the gateway for the projector. You can input a number from 0 to 255 in each field of the address. However, the following <u>Gateway addresses</u> ▶▶ cannot be used. 0.0.0.0, 127.x.x.x, 224.0.0.0 to 255.255.255.255 (where x is a number from 0 to 255)
MAC Address	Displays the MAC address.
IP Address Display	To prevent the IP address from being displayed on the LAN Standby screen, set this to <b>Off</b> .

## Mail Menu

When this is set, you receive an e-mail notification if a problem or warning occurs in the projector. 🖱️ "Reading Problem Mail Notification Function" p.107



Sub Menu	Function
<b>Mail Notification</b>	You can set whether or not ( <b>On/Off</b> ) to be notified by e-mail.
<b>SMTP Server</b>	You can input the <u>IP address</u> for the SMTP server for the projector. You can input a number from 0 to 255 in each field of the address. However, the following IP addresses cannot be used. 127.x.x.x, 224.0.0.0 to 255.255.255.255 (where x is a number from 0 to 255)
<b>Port Number</b>	You can input the port number for the SMTP server. The default value is 25. You can input numbers between 1 to 65535.
<b>Email Address 1/Email Address 2/Email Address 3</b>	You can input the e-mail address of the destination to send the notification e-mail to. You can register up to three destinations. You can enter up to 64 single-byte alphanumeric characters for the e-mail addresses. You cannot enter more than 32 characters on the configuration menu. When setting from Web Control, you can enter more than 32 characters. 🖱️ p.105
<b>Setting a Notification Event</b>	You can select the problems or warnings to be notified about by e-mail. When the selected problem or warning occurs in the projector, an e-mail is sent to the specified <b>Email Address</b> notifying that a problem or warning has occurred. You can select multiple items from the displayed items.



## Others Menu



Sub Menu	Function
<b>SNMP</b>	Set this parameter to <b>On</b> when using <a href="#">SNMP</a> to monitor the projector. To use SNMP to monitor the projector, you need to install the SNMP manager program on your computer. SNMP should be managed by a network administrator.
<b>Trap IP Address 1/Trap IP Address 2</b>	When <b>SNMP</b> is set to <b>On</b> , you can set up to two IP addresses as SNMP trap notification destinations. You can input a number from 0 to 255 in each field of the address. However, the following IP addresses cannot be used. 127.x.x.x, 224.0.0.0 to 255.255.255.255 (where x is a number from 0 to 255)
<b>Priority Gateway</b>	For the priority gateway, select either <b>Wired</b> or <b>Wireless</b> .
<b>AMX Device Discovery</b>	When the projector is connected to a network, set this to <b>On</b> to allow the projector to be detected by <a href="#">AMX Device Discovery</a> . Set this to <b>Off</b> if you are not connected to an environment controlled with a controller from AMX or AMX Device Discovery.
<b>RoomView</b>	Set this parameter to <b>On</b> only when using Crestron RoomView® to monitor and control the projector over a network. Normally, leave this parameter set to <b>Off</b> . <a href="#">"About Crestron RoomView"</a> p.112 Changes in projector settings take effect upon restarting. The following functions cannot be used when it is set to <b>On</b> . <ul style="list-style-type: none"> <li>• Web Control</li> <li>• Message Broadcasting (EasyMP Monitor plugin)</li> </ul>

## Reset Menu

Resets all of the network settings.



Sub Menu	Function
Reset network settings.	To reset all of the network settings, select <b>Yes</b> . After you reset all the settings, the <b>Basic</b> menu appears.

Lets you check the status of the image signals being projected and the status of the projector. Items that can be displayed vary depending on the image signal or input source being projected as shown in the following screen shots.

### RGB Signal/Component Video▶▶ Signal

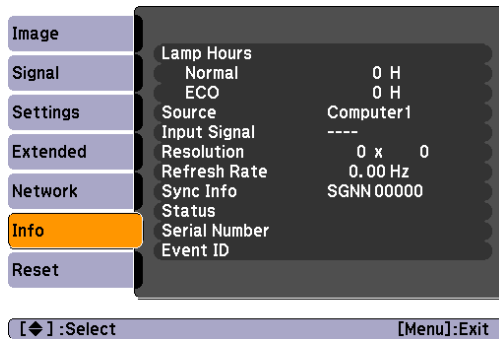

### Composite video▶▶ Signal/S-Video▶▶ Signal

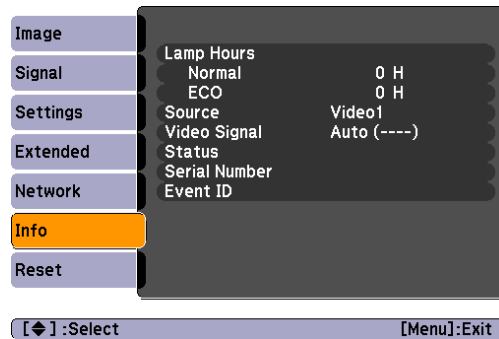

### USB/LAN

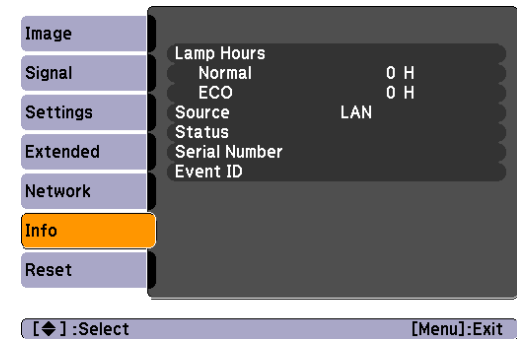

Sub Menu	Function
Lamp Hours	You can display the cumulative lamp operating time*1. When it reaches the lamp warning time, the characters are displayed in yellow.
Source	You can display the Source name for the connected equipment currently being projected.
Input Signal	You can display the content of <b>Input Signal</b> set in the <b>Signal</b> menu according to the Source.
Resolution	You can display the Resolution.
Video Signal	You can display the content of <b>Video Signal</b> set in the <b>Signal</b> menu.
Refresh Rate	You can display the <u>Refresh Rate</u> ▶▶.
Sync Info	You can display the image signal information. This information may be needed if service is required.
Status	This is information about errors that have occurred on the projector. This information may be needed if service is required.
Serial Number	Displays the projector's serial number.
Event ID	When problems occur when the projector and computer are connected through the network, information on the problem is displayed using an Event ID. Refer to the following page for information on interpreting the Event ID.  <a href="#">p.92</a>

\*1 The cumulative use time is displayed as "0H" for the first 10 hours. 10 hours and above is displayed as "10H", "11H", and so on.

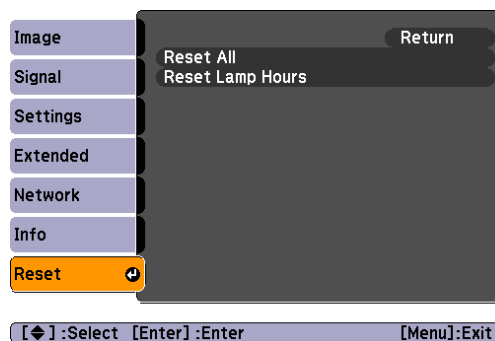

Sub Menu	Function
<b>Reset All</b>	You can reset all items in the configuration menu to their default settings. The following items are not reset to their defaults: Items for Password, <b>Input Signal</b> , <b>User's Logo</b> , <b>Multi-screen</b> , all items for <b>Network</b> menus, <b>Lamp Hours</b> , and <b>Language</b> .
<b>Reset Lamp Hours</b>	You can clear the cumulative lamp hours use time, and return it to "0H". Reset when you replace the lamp.



# Troubleshooting

This chapter explains how to identify problems and what to do if a problem is found.

If a problem occurs with the projector, the Help screen is displayed to assist you by pressing the [Help] button. You can solve problems by answering the questions.

## Procedure

- 1 Press the [Help] button.

The Help screen is displayed.

### Using the Remote Control

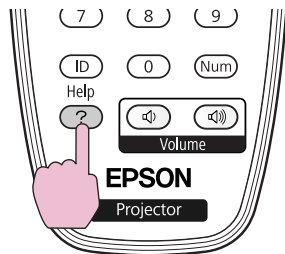

### Using the Control panel

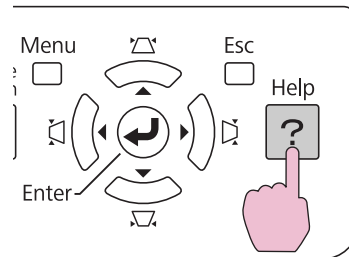

- 2 Select a menu item.

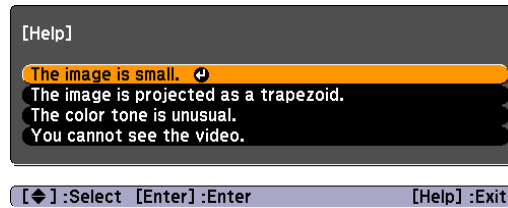

### Using the Remote Control

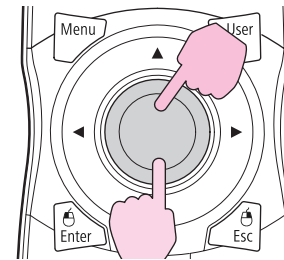

### Using the Control panel

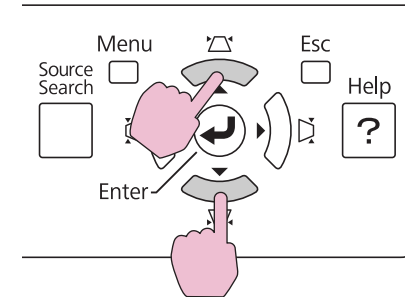

**3**

## Confirm the selection.

### Using the Remote Control

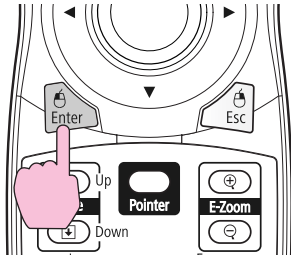

### Using the Control panel

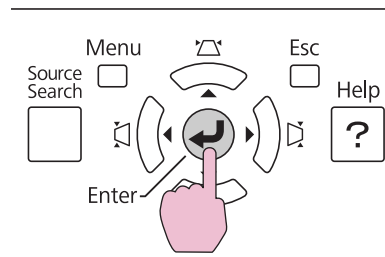

Questions and solutions are displayed as shown on the screen below.  
Press the [Help] button to exit Help.

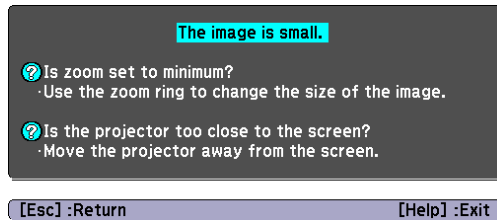

If the Help screen does not provide a solution to the problem, refer to "Problem Solving" p.80.

If you are having a problem with the projector, first check the projector's indicators and refer to "Reading the Indicators" below.

If the indicators do not show clearly what the problem might be, refer to "When the Indicators Provide No Help". [☛ p.84](#)

## Reading the Indicators

These indicators indicate the operating status of the projector.

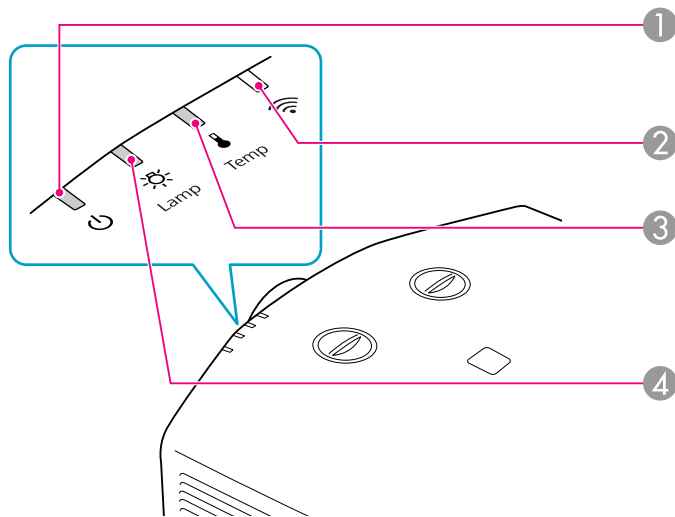

① Indicates the operating status.



Standby condition

When the [⏻] button is pressed in this condition, projection starts.



Preparing network monitoring (maximum approx. 20 seconds) or cool down in progress

Buttons are disabled while the indicator is flashing.



Warming up

Warm-up time is about 30 seconds. After warm-up is complete, the indicator stops flashing.

[⏻] button does not function during warm-up.



Projecting

② Indicates the operating status of wireless LAN when the Wireless LAN unit is installed. [☛ "Reading the wireless LAN indicators" p.135](#)



























- ③ Indicates the internal temperature status.
- ④ Indicates the projection lamp status.

Refer to the following table to see what the indicators mean and how to remedy problems that they indicate. If all indicators are off, check that the power cable is connected correctly and that the power is being supplied normally. Sometimes, when the power cable is unplugged, the ⏻ indicator remains lit for a short period, but this is not a fault.

## ⏻ Indicator is lit or flashing red

 : Lit    
  : Flashing:    
  : Off

















Status	Cause	Remedy or Status
     	Internal Error	Stop using the projector, disconnect the power cable from the electrical outlet, and contact your local dealer or the nearest address provided in the Support and Service Guide  <a href="#">Epson Projector Contact List</a>
     	Fan Error Sensor Error	Stop using the projector, disconnect the power cable from the electrical outlet, and contact your local dealer or the nearest address provided in the Support and Service Guide  <a href="#">Epson Projector Contact List</a>
     	High Temp Error (overheating)	The lamp turns off automatically and projection stops. Wait for about five minutes. After about five minutes the projector switches to standby mode, so check the following two points. <ul style="list-style-type: none"> <li>• Check that the air filter and air exhaust vent are clear, and that the projector is not positioned against a wall.</li> <li>• If the air filter is clogged, clean or replace it.  <a href="#">p.94, p.100</a></li> </ul> If the error continues after checking the points above, stop using the projector, disconnect the power cable from the electrical outlet, and contact your local dealer or the nearest address provided in the Support and Service Guide.  <a href="#">Epson Projector Contact List</a>
	Filter Airflow Error	Check the following two points. <ul style="list-style-type: none"> <li>• Check that the air filter and air exhaust vent are clear, and that the projector is not positioned against a wall.</li> <li>• If the air filter is clogged, clean or replace it.  <a href="#">p.94, p.100</a></li> </ul> If the error continues after checking the points above, stop using the projector, disconnect the power cable from the electrical outlet, and contact your local dealer or the nearest address provided in the Support and Service Guide  <a href="#">Epson Projector Contact List</a>

Status	Cause	Remedy or Status
 	Lamp Error Lamp Failure Lamp Cover Open	Check the following two points. <ul style="list-style-type: none"> <li>• Take out the lamp and check whether it is cracked. <a href="#">☞ p.97</a></li> <li>• Clean the air filter. <a href="#">☞ p.94</a></li> </ul> <p><b>If it is not cracked:</b> Re-fit the lamp and turn on the power.</p> <p><b>If the error continues:</b> Replace the lamp with a new lamp and turn on the power.</p> <p><b>If the error continues:</b> Stop using the projector, disconnect the power cable from the electrical outlet, and contact your local dealer or the nearest address provided in the Support and Service Guide. <a href="#">☞ Epson Projector Contact List</a></p> <p><b>If it is cracked:</b> Replace it with a new lamp, or contact your local dealer for further advice. If replacing the lamp yourself, be careful to avoid pieces of broken glass (you cannot continue projecting until the lamp is replaced). <a href="#">☞ Epson Projector Contact List</a></p> <p>When using at an altitude of 1500 m or more, set <b>High Altitude Mode</b> to <b>On</b>. <a href="#">☞ p.57</a></p> <p>Check that the lamp cover and the lamp are securely installed. <a href="#">☞ p.97</a>                      If the lamp cover or the lamp is not securely installed, the lamp does not switch on.</p>
 	Power Err. (Ballast)	Stop using the projector, disconnect the power cable from the electrical outlet, and contact your local dealer or the nearest address provided in the Support and Service Guide. <a href="#">☞ Epson Projector Contact List</a>



## Indicator is flashing or lit

: Lit   
 : Flashing   
 : Off   
 : Varies according to the projector status

Status	Cause	Remedy or Status
 	High Temp Warning	(This is not an abnormality. However, if the temperature rises too high again, projection stops automatically.) <ul style="list-style-type: none"> <li>• Check that the air filter and air exhaust vent are clear, and that the projector is not positioned against a wall.</li> <li>• If the air filter is clogged, clean or replace it. <a href="#">☞ p.94, p.100</a></li> </ul>
 	Replace Lamp	Replace it with a new lamp. <a href="#">☞ p.97</a> If you continue to use the lamp after the replacement period has passed, the possibility that the lamp may explode increases. Replace it with a new lamp as soon as possible.

Status	Cause	Remedy or Status
     	Low Air Flow	<p>(This is not an abnormality. However, projection stops automatically if the airflow falls any further.)</p> <p>The message "The air filter is clogged. Clean or replace the air filter." is displayed. Check the following two points.</p> <ul style="list-style-type: none"> <li>• Check that the air filter and air exhaust vent are clear, and that the projector is not positioned against a wall.</li> <li>• If the air filter is clogged, clean or replace it.  <a href="#">p.94, p.100</a></li> </ul> <p>If the Low Air Flow status continues after cleaning the air filter, replace the air filter with a new one.  <a href="#">p.100</a></p> <p>If the error continues after checking the points above, stop using the projector, disconnect the power cable from the electrical outlet, and contact your local dealer or the nearest address provided in the Support and Service Guide  <a href="#">Epson Projector Contact List</a></p>
     	Air Filter Notice	<p>The following message may also be displayed: "Time to clean the air filter. Clean or replace the air filter." Clean the air filter.  <a href="#">p.94</a></p> <p>If the air filter is stained yellow with tobacco smoke and cannot be cleaned, replace it with a new one.</p> <p>The indicators or messages regarding "Air Filter Notice" are displayed only when <b>Air Filter Notice</b> is set to <b>On</b>, on the configuration menu's <b>Extended</b> menu.  <a href="#">p.57</a></p>













- If the projector is not operating properly, even though the indicators are all showing normal, refer to "When the Indicators Provide No Help".  [p.84](#)
- If the error is not indicated in this table, stop using the projector, disconnect the power cable from the electrical outlet, and contact your local dealer or the nearest address provided in the Support and Service Guide.  [Epson Projector Contact List](#)

## When the Indicators Provide No Help

If any of the following problems occur and the indicators do not offer a solution, refer to the pages given for each problem.





### Problems relating to images

- "No images appear"  p.85  
Projection does not start, the projection area is completely black, the projection area is completely blue, and so on.
- "Moving images are not displayed (only the moving image portion turns black)."  p.85  
Moving images being projected from a computer appear black and nothing is projected.
- "Projection stops automatically"  p.85
- "The message "Not supported" is displayed."  p.86
- ""No Signal" is displayed."  p.86
- "Images are fuzzy or out of focus"  p.86
- "Interference or distortion appear in images"  p.87  
Problems such as interference, distortion, or black & white checked patterns appear.
- "The image is truncated (large) or small, or the aspect is not suitable"  p.87  
Only part of the image is displayed, or the height and width ratios of the image are not correct, and so on.
- "Image colors are not right"  p.88  
The whole image appears purplish or greenish, images are black & white, colors appear dull, and so on... (Computer monitors and LCD screens have different color reproduction performance, so that the colors projected by the projector and the colors appearing on the monitor may not necessarily match, but this is not a sign of a problem.)
- "Images appear dark"  p.88

### Problems when projection starts

- "No power supplied"  p.89

### Other problems

- "No sound can be heard or the sound is faint"  p.90
- "The remote control does not work"  p.90
- "Nothing appears on the external monitor"  p.91
- "I want to change the language for messages and menus"  p.91
- "Mail is not received even if a problem occurs in the projector"  p.91

### Interpreting Event IDs

-  p.92

## Problems relating to images

No images appear

Check	Remedy
Did you press the [⏻] button?	Press the [⏻] button to turn the power on.
Are the indicators switched off?	The power cable is not connected correctly or power is not being supplied normally. Connect the projector's power cable correctly. 🖱️ <a href="#">Quick Start Guide</a> Check that your electrical outlet or power source is functioning correctly.
Is A/V Mute active?	Press the [A/V Mute] button on the remote control to cancel A/V Mute. 🖱️ <a href="#">p.34</a>
Are the configuration menu settings correct?	Reset All of the settings. 🖱️ <a href="#">Reset Menu - Reset All p.76</a>
Is the projected image completely black? <b>Only when projecting computer images</b>	Some input images, such as screen savers, may be completely black.
Is the image signal format setting correct? <b>Only when projecting images from a video source</b>	Change the setting according to the signal for the connected equipment. 🖱️ <a href="#">Signal Menu - Video Signal p.53</a>

Moving images are not displayed (only the moving image portion turns black).

Check	Remedy
Is the computer's image signal being output to the LCD and the monitor? <b>Only when projecting images from a laptop computer or a computer with a built-in LCD screen</b>	Change the image signal to external output only. 🖱️ Check your computer's documentation.

Projection stops automatically

Check	Remedy
Is <b>Sleep Mode</b> set to <b>On</b> ?	Press the [⏻] button to turn the power on. If you do not want to use Sleep Mode, change the setting to <b>Off</b> . 🖱️ <a href="#">Extended Menu - Operation - Sleep Mode p.57</a>

The message "Not supported" is displayed.

Check	Remedy
Is the image signal format setting correct? <b>Only when projecting images from a video source</b>	Change the setting according to the signal for the connected equipment. 🖱️ <a href="#">Signal Menu - Video Signal p.53</a>
Do the image signal Resolution and the Refresh Rate correspond to the mode? <b>Only when projecting computer images</b>	Refer to the computer's documentation for how to change the image signal Resolution and the Refresh Rate output from the computer. 🖱️ <a href="#">"Supported Monitor Displays" p.143</a>

"No Signal" is displayed.

Check	Remedy
Are the cables connected correctly?	Check that all the cables required for projection are securely connected. 🖱️ <a href="#">p.126, p.131</a>
Is the correct input port selected?	Change the image by pressing the [Source Search] button on the remote control or the control panel. 🖱️ <a href="#">p.25</a>
Is the power for the computer or video source turned on?	Turn the power on for the equipment.
Are the image signals being output to the projector? <b>Only when projecting images from a laptop computer or a computer with a built-in LCD screen</b>	If the image signals are only being output to the computer's LCD monitor or to the accessory monitor, you need to change the output to an external destination as well as the computer's own monitor. For some computer models, when the image signals are output externally, they no longer appear on the LCD monitor or accessory monitor. 🖱️ <a href="#">p.128</a> If the connection is made while the power of the projector or computer is already turned on, the function [Fn] key that changes the computer's image signal to external output may not work. Turn the power for the computer and the projector off and then back on again.

Images are fuzzy or out of focus

Check	Remedy
Is the focus adjusted correctly?	Turn the focus ring to adjust the focus. 🖱️ <a href="#">Quick Start Guide</a>
Is the projector at the correct distance?	Is it projecting outside of the recommended projection distance range? Setup within the recommended range. 🖱️ <a href="#">p.141</a>
Is the Keystone adjustment value too large?	Lower the projection angle to reduce the amount of keystone correction. 🖱️ <a href="#">p.23</a>





Check	Remedy
Has condensation formed on the lens?	If the projector is suddenly taken from a cold environment to a warm environment, or if sudden ambient temperature changes occur, condensation may form on the surface of the lens, and this may cause the images to appear fuzzy. Set the projector up in the room about one hour before it is used. If condensation forms on the lens, turn the projector off and wait for the condensation to disappear.

Interference or distortion appear in images







Check	Remedy
Is the image signal format setting correct? <b>Only when projecting images from a video source</b>	Change the setting according to the signal for the connected equipment. 🖱️ <a href="#">Signal Menu - Video Signal p.53</a>
Are the cables connected correctly?	Check that all the cables required for projection are securely connected. 🖱️ <a href="#">p.126, p.128</a>
Is an extension cable being used?	If an extension cable is used, electrical interference may affect the signals. Use the cables supplied with the projector to check if the cables you are using may be causing the problem.
Is the correct resolution selected? <b>Only when projecting computer images</b>	Set the computer so that the signals being output are compatible with the projector. 🖱️ "Supported Monitor Displays" <a href="#">p.143</a> 🖱️ Computer documentation
Are the "Sync.▶▶" and "Tracking▶▶" settings adjusted correctly? <b>Only when projecting computer analog RGB signals</b>	Press the [Auto] button on the remote control or the [Enter] button on the control panel to perform automatic adjustment. If the images are not adjusted correctly after using automatic adjustment, you can make the adjustments using <b>Sync.</b> and <b>Tracking</b> from the configuration menu. 🖱️ <a href="#">Signal Menu - Tracking, Sync. p.53</a>
Is the <b>Resolution</b> set to <b>Manual</b> ? <b>Only when projecting on a split screen</b>	The image may be collapsed if the <b>Resolution</b> on the configuration menu and the resolution of the projected image are not the same. If the image is collapsed, set the <b>Resolution</b> to <b>Auto</b> . 🖱️ <a href="#">Signal Menu - Resolution p.53</a>

The image is truncated (large) or small, or the aspect is not suitable





Check	Remedy
Is the aspect adjusted correctly?	Press the [Aspect] button on the remote control to select an aspect suitable for the input source. 🖱️ <a href="#">p.27</a>
Is a wide panel computer image being projected? <b>Only when projecting computer images</b>	Change the setting according to the signal for the connected equipment. 🖱️ <a href="#">Signal Menu - Resolution p.53</a>
Is the image still being enlarged by E-Zoom?	Press the [Esc] button on the remote control to cancel E-Zoom. 🖱️ <a href="#">p.36</a>

Check	Remedy
Is <b>Position</b> adjusted correctly?	Press the [Auto] button on the remote control or the [Enter] button on the control panel to perform automatic adjustment when projecting the computer analog RGB signals. If the images are not adjusted correctly after using automatic adjustment, you can make the adjustments using <b>Position</b> from the configuration menu. Apart from computer analog RGB signals, you can adjust other signals while projecting by adjusting <b>Position</b> from the configuration menu.  <b>Signal Menu - Menu Position p.53</b>
Is the computer set for dual display? <b>Only when projecting computer images</b>	If dual display is activated in the "Display Properties" of the computer's Control panel, only about half of the image on the computer screen is projected. To display the entire image on the computer screen, turn off the dual display setting.  Computer video driver documentation
Is the correct resolution selected? <b>Only when projecting computer images</b>	Set the computer so that the signals being output are compatible with the projector.  "Supported Monitor Displays" p.143  Computer documentation

## Image colors are not right

Check	Remedy
Do the input signal settings match the signals from the connected device?	Change the setting according to the signal for the connected equipment.  <b>Signal Menu - Input Signal, Video Signal p.53</b>
Is the image <b>Brightness</b> set correctly?	Adjust the <b>Brightness</b> setting from the configuration menu.  <b>Image Menu - Brightness p.51</b>
Are the cables connected correctly?	Check that all the cables required for projection are securely connected.  p.126, p.128
Is <b>Contrast</b>  adjusted correctly?	Adjust the <b>Contrast</b> setting from the configuration menu.  <b>Image Menu - Contrast p.51</b>
Is the <b>Color Adjustment</b> correct?	Adjust the <b>Color Adjustment</b> setting from the configuration menu.  <b>Image Menu - Color Adjustment p.51</b>
Are the <b>Color Saturation</b> and <b>Tint</b> adjusted correctly? <b>Only when projecting images from a video source</b>	Adjust the <b>Color Saturation</b> and <b>Tint</b> settings from the configuration menu.  <b>Image Menu - Color Saturation, Tint p.51</b>

## Images appear dark





Check	Remedy
Is the image <b>Brightness</b> set correctly?	Adjust the <b>Brightness</b> and <b>Power Consumption</b> settings from the configuration menu.  <b>Image Menu - Brightness p.51</b>  <b>Settings Menu - Power Consumption p.55</b>
Is <b>Contrast</b>  adjusted correctly?	Adjust the <b>Contrast</b> setting from the configuration menu.  <b>Image Menu - Contrast p.51</b>



Check	Remedy
Is the lamp due for replacement?	When the lamp is nearly ready for replacement, the images become darker and the color quality becomes poorer. When this happens, replace the lamp with a new lamp.  <a href="#">p.97</a>



## Problems when projection starts

### No power supplied







Check	Remedy
Did you press the [⏻] button?	Press the [⏻] button to turn the power on.
Are the indicators switched off?	The power cable is not connected correctly or power is not being supplied normally. Disconnect and then reconnect the power cable.  <a href="#">Quick Start Guide</a> Check that your electrical outlet or power source is functioning correctly.
Do the indicators turn on and off when the power cable is touched?	There is probably a poor contact in the power cable, or the power cable may be defective. Reinsert the power cable. If this does not solve the problem, stop using the projector, disconnect the power cable from the electrical outlet, and contact your local dealer or the nearest address provided in the Support and Service Guide.  <a href="#">Epson Projector Contact List</a>
Is the <b>Control Panel Lock</b> set to <b>Full Lock</b> ?	Press the [⏻] button on the remote control. If you do not want to use Control Panel Lock, change the setting to <b>Off</b> .  <a href="#">Settings Menu - Control Panel Lock p.55</a>
Is the correct setting for the remote receiver selected?	Check the <b>Remote Receiver</b> from the configuration menu.  <a href="#">Settings Menu - Remote Receiver p.55</a>
Was the power cable plugged back in or was the breaker turned on immediately after Direct Power Off?	When the operation to the left is performed when <b>Direct Power On</b> is set to <b>On</b> , the power may not turn back on. Press the [⏻] button to turn the power back on.
Is the ID switch on the side of the remote control set to On?	When the switch is set to On, you can use the remote control to operate only a projector with a matching ID. Set ID switch to Off.  <a href="#">p.39</a>

## Other problems

No sound can be heard or the sound is faint

Check	Remedy
Is the audio source connected correctly?	Disconnect the cable from the audio input port, and then reconnect the cable.
Is the volume adjusted to the minimum setting?	Adjust the volume so that sound can be heard.  <a href="#">Quick Start Guide</a>
Is A/V Mute active?	Press the [A/V Mute] button on the remote control to cancel A/V Mute.  <a href="#">p.34</a>
Is the audio cable's specification "No resistance"?	When using a commercially available audio cable, make sure it is labeled "No resistance".
Is it connected with an HDMI cable?	If no audio is output when connecting via an HDMI cable, set the connected equipment to PCM output.
Is the correct setting for the <b>LAN Audio Input</b> selected? <b>Only when the input source is LAN</b>	If the audio from a computer that is connected through a network is not output, check the setting of the <b>LAN Audio Input</b> on the configuration menu.  <a href="#">Settings Menu - Audio Input - LAN Audio Input p.55</a>

The remote control does not work

Check	Remedy
Is the remote control light-emitting area pointing towards the remote receiver on the projector when it is operated?	Point the remote control towards the Remote Receiver.  <a href="#">p.17</a>
Is the remote control too far from the projector?	The operating range for the remote control is about 15 m.  <a href="#">p.17</a>
Is direct sunlight or strong light from fluorescent lamps shining onto the Remote Receiver?	Set the projector up in a location where strong light does not shine onto the remote receiver. Or set the remote receiver to <b>Off</b> from <b>Remote Receiver</b> in the configuration menu.  <a href="#">Settings Menu - Remote Receiver p.55</a>
Is the correct setting for the remote receiver selected?	Check the <b>Remote Receiver</b> from the configuration menu.  <a href="#">Settings Menu - Remote Receiver p.55</a>
Are the batteries dead or have the batteries been inserted correctly?	Make sure the Batteries are inserted correctly or replace the batteries with new ones if necessary.  <a href="#">p.15</a>
Are the remote control ID and the projector ID matched?	Make sure the ID for the projector you want to operate and the ID for the remote control match. To operate all projectors by remote control regardless of the ID setting, set the ID switch on the side of the remote control to Off.  <a href="#">p.38</a>
Does <b>Remote Control Type</b> match the remote control that you are using?	Check the <b>Remote Control Type</b> on the configuration menu.  <a href="#">Extended Menu - Operation - Remote Control Type p.57</a>
Is the optional remote control cable connected to the remote control or to the projector's remote port?	When the remote control cable is connected, the remote control light-emitting area or the projector's remote receiver are disabled. When not using the remote control cable set, disconnect it from the remote control and the remote port.



Nothing appears on the external monitor

Check	Remedy
Are you trying to display an image from an input port other than the Computer1 input port or the BNC input port?	Only RGB signals from the Computer1 input port or the BNC input port can be displayed on an external monitor.
Are you projecting a split screen?	Only RGB signals projected on the left screen from the Computer1 input port or the BNC input port can be displayed on an external monitor.  <a href="#">p.30</a>

I want to change the language for messages and menus



Check	Remedy
Change the <b>Language</b> setting.	Adjust the <b>Language</b> setting from the configuration menu.  <b>Extended Menu - Language</b> <a href="#">p.57</a>

Mail is not received even if a problem occurs in the projector

Check	Remedy
Is <b>Standby Mode</b> set to <b>Communication On</b> ?	To use the Mail Notification function when the projector is in standby, set <b>Communication On in Standby Mode</b> from the configuration menu.  <b>Extended Menu - Standby Mode</b> <a href="#">p.57</a>
Did a fatal abnormality occur and the projector come to a sudden stop?	When the projector comes to a sudden stop, e-mail cannot be sent. If the abnormal state continues, contact your local dealer or the nearest address provided in the Support and Service Guide.  <a href="#">Epson Projector Contact List</a>
Is power being supplied to the projector?	Check that your electrical outlet or power source is functioning correctly.
Is <b>Mail</b> function set correctly in the configuration menu?	Mail notification of problems is sent according to the <b>Mail</b> settings in the configuration menu. Check if it is set correctly.  <b>Network menu - Mail</b> <a href="#">p.72</a>

## Interpreting Event IDs

Check the event ID and perform the remedy given below. If the problem cannot be solved, contact the network administrator or one of the following contact addresses.  [Epson Projector Contact List](#)

Event ID	Cause	Remedy
0432 0435	Failed to startup EasyMP Network Projection.	Restart the projector.
0434 0481 0482 0485	Network communication is unstable.	Check the status of network communications. Wait for a while and then try connecting again.
0433	An image that was transferred cannot be reproduced.	Restart EasyMP Network Projection.
0484	Communications was cut off from the computer.	
04FE	EasyMP Network Projection ended unexpectedly.	Check the status of network communications. Restart the projector.
04FF	A system error occurred in the projector.	Restart the projector.
0891	The same SSID access point cannot be found.	Set the computer, the access point, and the projector to the same SSID.
0892	The WPA and WPA2 authentication methods are not the same.	Check the setting of wireless LAN security to see if it is correct.  <b>Network Menu - Security Menu p.60</b>
0893	The WEP, TKIP, and AES encoding methods are not the same.	
0894	Communications was cut off because a connection was made to the wrong access point.	Check with the network administrator and follow their instructions.
0898	Failed to obtain the DHCP.	Check the DHCP server to see if it is operating correctly and check the LAN cable to see if it is connected correctly. Turn off DHCP if it is not being used.  <b>Network Menu - Wireless LAN Menu p.63, Wired LAN Menu p.71</b>
0899	Other connection errors	If the problem cannot be solved by restarting the projector or EasyMP Network Projection, contact one of the following contact addresses.  <a href="#">Epson Projector Contact List</a>



# Maintenance

This chapter explains the maintenance methods that are required to ensure a long projector service life.

You should clean the projector if it becomes dirty or if the quality of projected images starts to deteriorate.

## Warning

*Do not use sprays containing a flammable gas to remove dirt or dust which is adhering to parts such as the lens or filter of the projector. This could be a cause of the fire for the high temperature of the lamp inside the unit.*

## Cleaning the Projector's Surface

Clean the projector's surface by wiping it gently with a soft cloth.

If the projector is particularly dirty, moisten the cloth with water containing a small amount of neutral detergent, and then firmly wring the cloth dry before using it to wipe the projector's surface.

### Attention

*Do not use volatile substances such as wax, alcohol, or thinner to clean the projector's surface. The quality of the case may change or become discolored.*

## Cleaning the Lens

Use a commercially available cloth for cleaning glasses to gently wipe the lens.

### Attention

*Do not rub the lens with harsh materials or subject the lens to shocks, as it can easily become damaged.*

## Cleaning the Air Filter

If one of the following messages is displayed or the temperature indicator flashes green, clean the air filter.

Time to clean the air filter.

Clean or replace the air filter.

### Attention

- If dust collects on the air filter it can cause the internal temperature of the projector to rise, and this can lead to problems with operation and shorten the optical engine's service life. Clean the air filter immediately when the message is displayed.
- If the air filter is stained yellow with tobacco smoke, it cannot be cleaned. In this case, replace it with a new air filter.  p.100
- Do not rinse the air filter in water. Do not use detergents or solvents.
- When using a brush for cleaning, use one with long soft bristles, and brush it lightly. If it is brushed too strongly, dust will be ground into the air filter and cannot be removed.

### Procedure

1

**After you turn off the projector's power and the confirmation buzzer beeps twice, disconnect the power cable.**

2

**Remove the air filter cover.**

Grip the air filter cover tab between your fingers and pull it straight out.

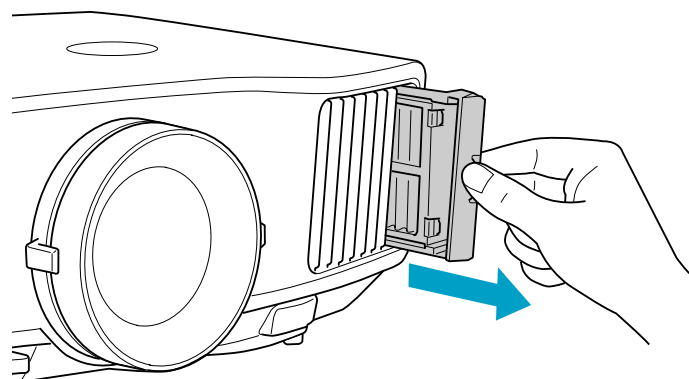

**3 Remove the air filter.**

Remove the air filter by placing your finger into the groove as shown in the following illustration.

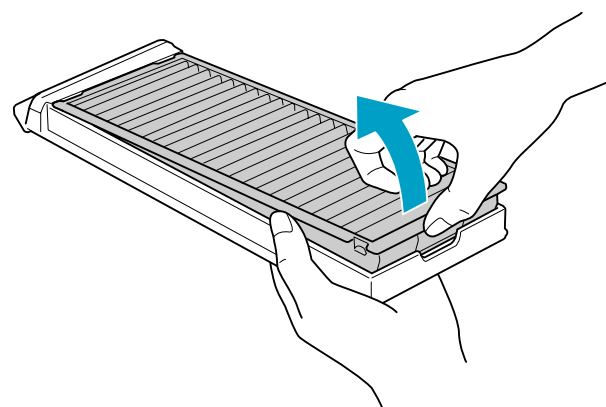

**4 With the front (the side with tabs) of the air filter facing down, tap the air filter four or five times to shake off the dust.**

Turn it over and tap the other side in the same way.

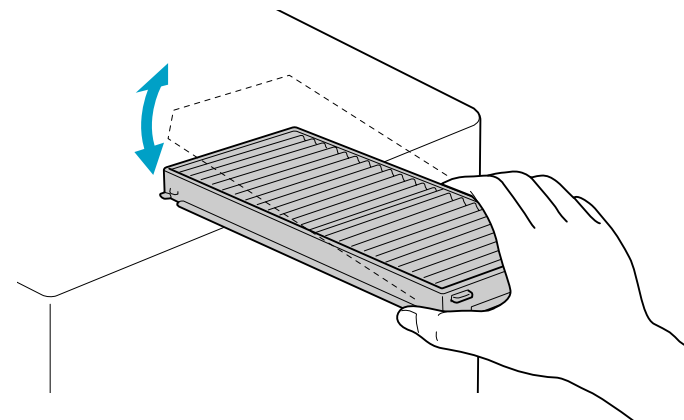

**Attention**

*If the air filter is hit too hard, it may become unusable due to deformities and cracks.*

**5 Remove any dust remaining on the air filter by using a vacuum cleaner from the front side.**

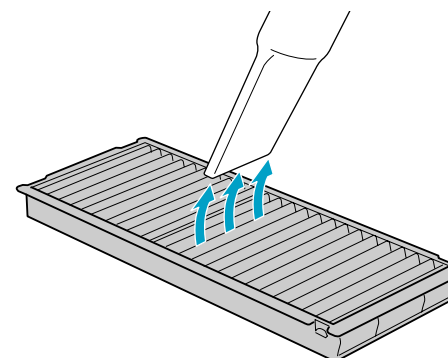

**6 Insert the air filter back into the air filter cover.**

Insert the tabs on the air filter into the holes in the cover, and press the air filter firmly into place.

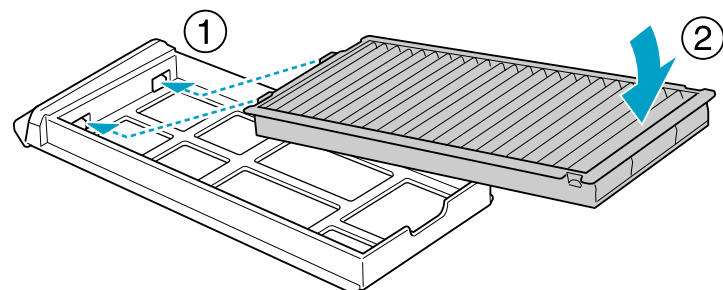

**7** Replace the air filter cover.

Press until it clicks into place.

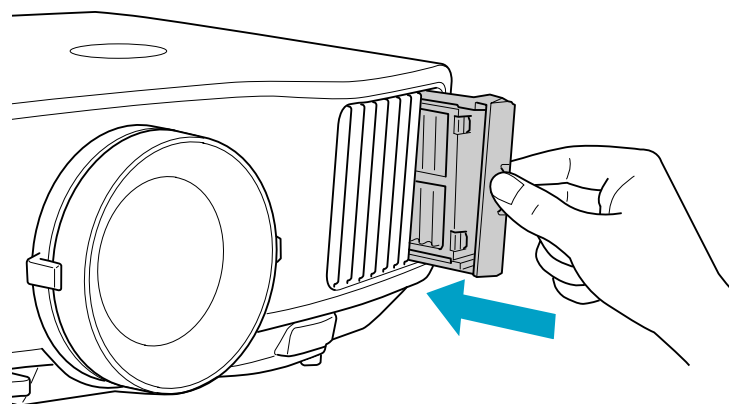

If a message is frequently displayed, even after cleaning, it is time to replace the air filter. Replace it with a new air filter. [p.100](#)



## Replacing the Lamp

### Lamp replacement period

It is time to replace the lamp when:

- The message "Replace the lamp." is displayed at the lower left of the projection screen when you start projecting.

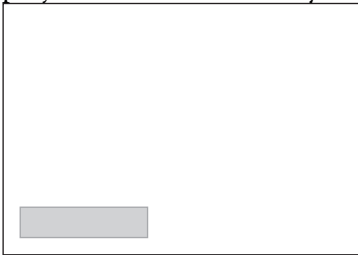

- The lamp indicator flashes orange.

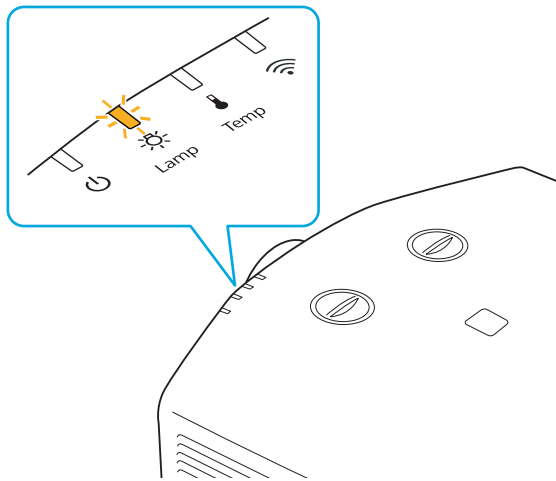



- The projected image gets darker or starts to deteriorate.

### Attention

- The lamp replacement message is set to appear after the following time periods in order to maintain the initial brightness and quality of the projected images.  
When using **Power Consumption** continually at Normal: About 1900 hours  
When using **Power Consumption** continually at ECO: About 2900 hours
- Do not turn the projector on immediately after turning it off. Turning the projector on and off frequently may shorten the life of the lamp.
- If you continue to use the lamp after the replacement period has passed, the possibility that the lamp may explode increases. When the lamp replacement message appears, replace the lamp with a new one as soon as possible, even if it is still working.
- Depending on the characteristics of the lamp and the way it has been used, the lamp may become darker or stop working before the lamp warning message appears. We recommend that you keep a replacement lamp on hand at all times.



We recommend that you clean the air filter whenever you replace the lamp.  [p.94](#)

Replace the air filter if it is discolored or if a message appears even after cleaning the air filter.  [p.100](#)

### How to replace the lamp

The lamp can be replaced even when the projector is suspended from a ceiling.

## Warning

- When replacing the lamp because they have stopped illuminating, there is a possibility that the lamp may be broken. If replacing the lamp of a projector which has been installed on the ceiling, you should always assume that the lamp is broken, and you should stand to the side of the lamp cover, not underneath it. Remove the lamp cover gently.
- Never disassemble or remodel the lamp. If a remodeled or reassembled lamp is installed into the projector and used, it could cause a fire, electric shock, or an accident.

## Caution

Wait until the lamp has cooled down sufficiently before removing the lamp cover. If the lamp is still hot, burns or other injuries may result. It takes about one hour after the power has been turned off for the lamp to be cool enough.

### Procedure

**1** After you turn off the projector's power and the confirmation buzzer beeps twice, disconnect the power cable.

**2** Wait until the lamp has cooled down, then remove the projector's lamp cover.

Loosen the lamp cover fixing screws with the screwdriver supplied with the new lamp or a + head screwdriver, and then remove the lamp cover. Because there is a string attached to the lamp cover to prevent it from falling, it should never fall even when replacing the lamp in a projector installed on the ceiling.

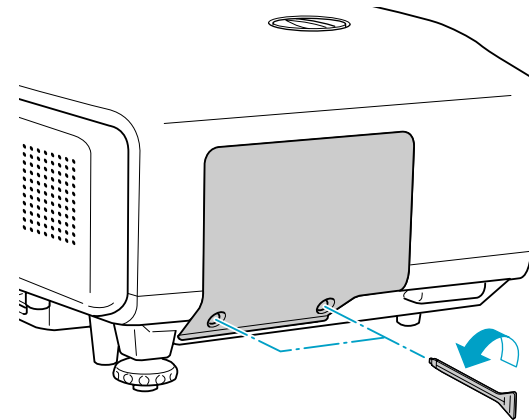

**3** Loosen the two lamp fixing screws.

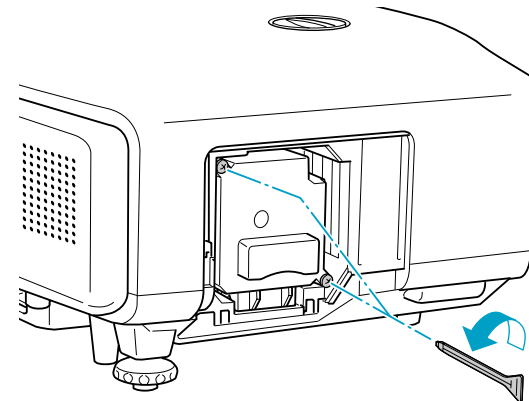

**4** Take out the old lamp.

If the lamp is cracked, replace it with a new lamp, or contact your local dealer for further advice.  [Epson Projector Contact List](#)

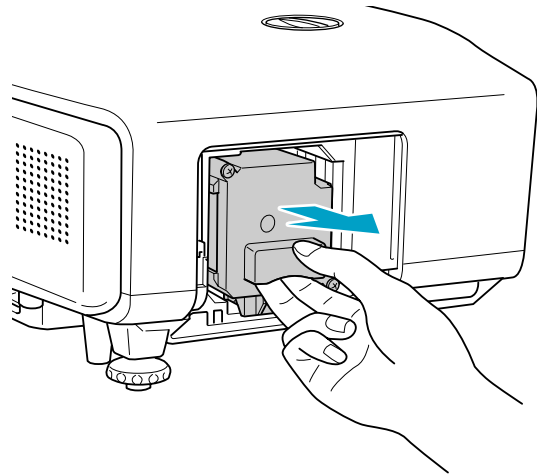

**5** Install the new lamp.

Insert the lamp along the guide rail in the correct direction so that it fits in place and press it firmly to the back.

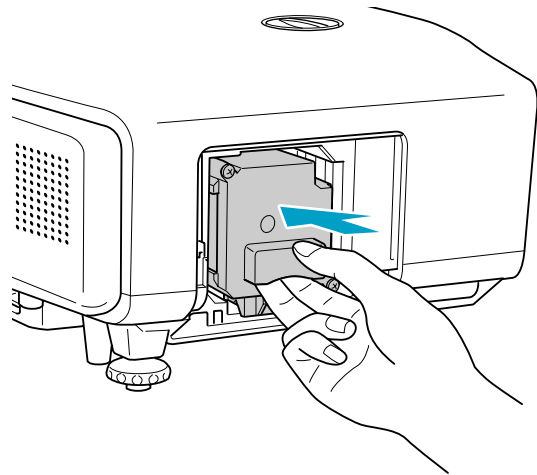

**6** Tighten the two lamp fixing screws.

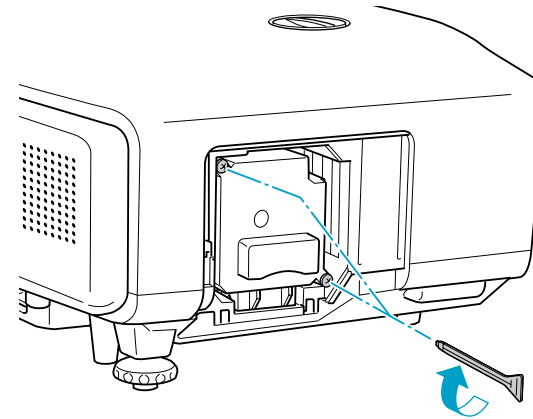

**7** Replace the lamp cover.

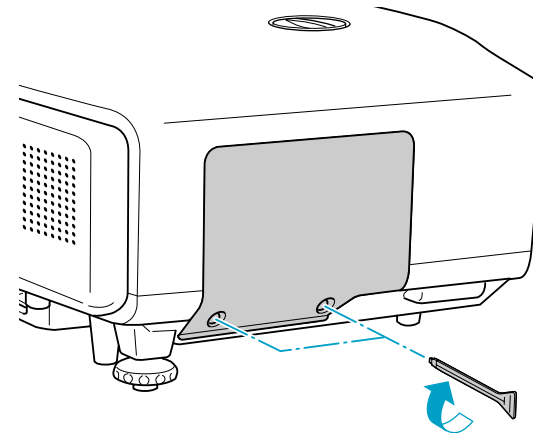

**Attention**

- Make sure you install the lamp securely. If the lamp cover is removed, the lamp turns off automatically as a safety precaution. If the lamp or the lamp cover is not installed correctly, the lamp will not turn on.
- This product includes a lamp component that contains mercury (Hg). Please consult your local regulations regarding disposal or recycling. Do not dispose of it with normal waste.

## Resetting the Lamp Hours

The projector records how long the lamp is turned on and a message and indicator notify you when it is time to replace the lamp. After replacing the lamp, make sure you reset the lamp hours from the Reset Menu.

☛ p.76



Only reset the lamp operating time after the lamp has been replaced. Otherwise, the lamp replacement period will not be indicated correctly.

## Replacing the Air Filter

### Air filter replacement period

It is time to replace the air filter when:

- The air filter is discolored.
- The message is displayed even though the air filter has been cleaned.

### How to replace the air filter

The air filter can be replaced even when the projector is suspended from a ceiling.

#### Procedure

**1** After you turn off the projector's power and the confirmation buzzer beeps twice, disconnect the power cable.

**2** Remove the air filter cover.

Grip the air filter cover tab between your fingers and pull it straight out.

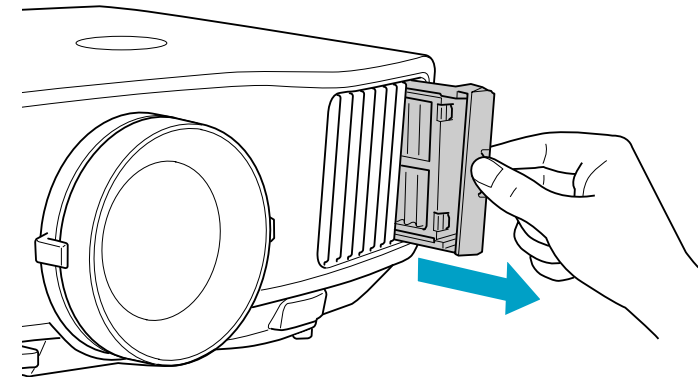

**3** Remove the air filter.

Remove the air filter by placing your finger into the groove as shown in the following illustration.

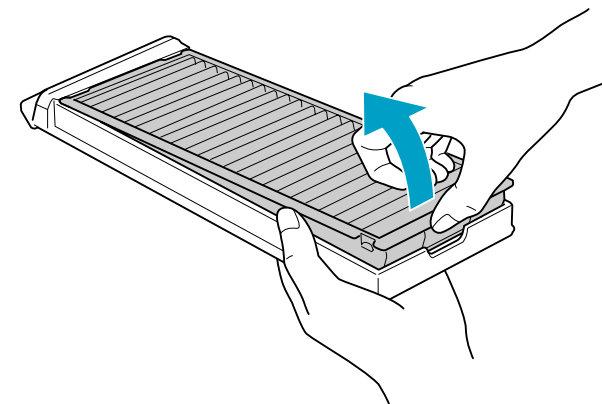

**4** Insert the new air filter into the air filter cover.

Insert the tabs on the air filter into the holes in the cover, and press the air filter firmly into place.

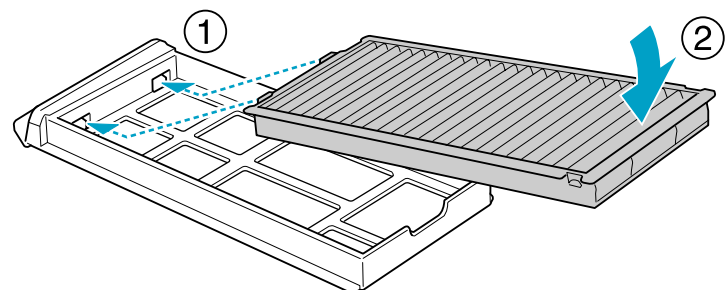

**5** Press until it clicks into place.

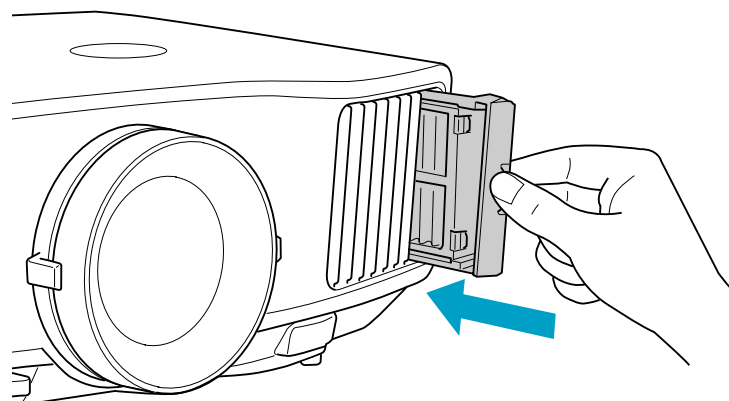

Dispose of used air filters properly in accordance with your local regulations.

Material quality of the frame section: Polypropylene

Material quality of the filter section: Polypropylene

There are many glass parts and precision components inside the projector. To prevent damage due to impacts when transporting, handle the projector as follows.

---

## Moving Nearby

Checking the following points, and then carry carefully by the handles.

- Turn off the power to the projector and disconnect all cables.
- Attach the lens cover to the lens.
- Store the foot.

---

## When Transporting

### Preparing packaging

After checking the points in "Moving Nearby", prepare the following and then pack up the projector.

- Set the vertical lens shift to the lowest position.  [p.20](#)
- Fit the protective lens pad that was used at the time of purchase.

### Notes when packing and transporting

Enclose the projector securely in buffer material to protect it from shock, and place it into a strong cardboard container. Be sure to notify the carrier company that the contents are fragile.



# Monitoring and Controls

This chapter explains the functions that can be used to monitor and control the projector.

EasyMP Monitor lets you carry out operations such as checking the statuses of multiple Epson projectors that are connected to a network at a computer monitor, and controlling the projectors from the computer.

Download the EasyMP Monitor software from the following website.

<http://www.epson.com>

Following are brief descriptions of the monitoring and control functions that can be carried out using EasyMP Monitor.

- **Registering projectors for monitoring and control**

Projectors on the network can be searched for automatically, and you can then select projectors to be registered from the projectors that are detected.

You can enter the IP addresses for target projectors to register them.

- **Registered projectors can also be assigned to groups so that they can be monitored and controlled in groups.**

- **Monitoring the statuses of registered projectors**

The power status (ON/OFF) for projectors and problems or warnings requiring attention can be checked visually by means of icons.

You can select groups of projectors or a single projector that you are interested in, and then check the cumulative lamp operating time or the details of information such as input sources, problems, and warnings for these projectors.

- **Controlling registered projectors**

Projectors can be selected in groups or as single projectors, and you can then carry out operations for the selected projectors such as turning the power on and off and switching their input sources.

Web Control functions can be used to change the settings in the projector's configuration menu.

If there are certain control actions which are carried out regularly at particular times or on particular days, you can use Timer Settings to register timer settings.

- **Mail Notification settings**

You can set e-mail addresses to which notifications are sent if a status requiring attention, such as a problem, occurs with a projector that has been registered.

- **Sending messages to registered projectors**

The Message Broadcasting plugin for EasyMP Monitor can be used to send JPEG files to registered projectors.



Download the Message Broadcasting plugin from the website given at the beginning of this chapter.



You can make Configuration menu settings and control the projector by using the Web browser of a computer that is connected to the projector via a network. Setup and control operations can be performed remotely if this function is used. In addition, since you can use the computer's keyboard, entering characters required for the setup is easier.

Use Microsoft Internet Explorer 6.0 or later as the Web browser. If using a Mac OS, use Safari or Firefox.



- Use the Advanced mode when connecting with a wireless LAN.  [p.63](#)
- Setup and control with a Web browser are possible if **Standby Mode** is set to **Communication On** from the **Extended** menu of the projector's Configuration menu, even if the projector is in standby state (when the power is off).  [p.57](#)

Some items cannot be set with a Web browser (but can be set from the Configuration Menu) and some items can be set only with a Web browser.

## Items in the Configuration menu that cannot be set by the web browser

- Items related to password settings
- All items on the Reset menu
- The following items on the Settings menu  
Quick Corner, Pointer Shape, User Button, and Test Pattern
- The following items on the Extended menu  
User's Logo, High Altitude Mode, BNC Sync Termination, Remote Control Type, and Language

## Items that can only be set in the Web browser

- Community Name
- Monitor Password

## Displaying Web Control

Use the following procedure to display Web Control.



If your Web browser is set up to connect via a proxy server, Web Control cannot be displayed. To use Web Control, you need to make network connection settings with a device other than a proxy server.

### Procedure



**1 Start the Web browser on the computer.**



**2 Enter the IP address of the projector in the address input box of the Web browser, and press the [Enter] key on the computer's keyboard.**

Web Control is displayed.

When Web Control Password is set in the Network menu from the projector's Configuration Menu, enter the Password. Enter **EPSONWEB** as the user name. Enter the characters set for the web control password as the password.

## Displaying Web Remote

The Web Remote function allows you to perform projector remote control operations from a Web browser.

### Procedure



**1 Display Web Control.**  ["Displaying Web Control" p.105](#)



**2 Click Web Remote.**



**3** The Web Remote screen appears.

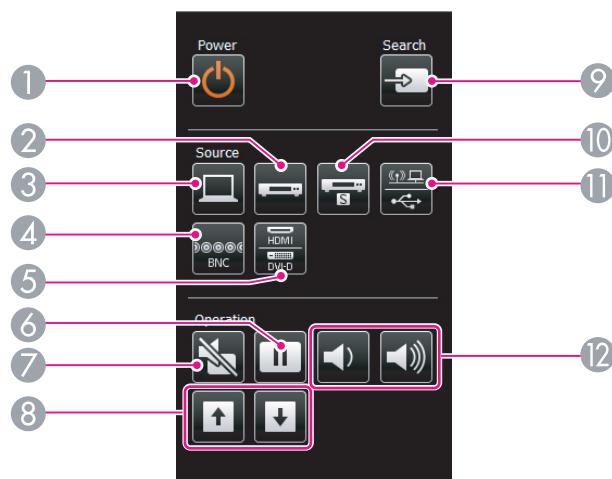

Name	Function
1 [Power] button	Turns the projector power On or Off.
2 [Video1/2] button	The input source alternates between <b>Video1</b> and <b>Video2</b> each time you click.
3 [Comp1/2] button	The input source will change to <b>Computer1</b> .
4 [BNC] button	The input source will change to <b>BNC</b> .
5 [DVI-D/HDMI] button	The input source alternates between <b>DVI-D</b> and <b>HDMI</b> each time you click.
6 [Freeze] button	Images are paused or unpaused.  p.34
7 [A/V Mute] button	Temporarily turns the audio and video on or off.  p.34

Name	Function
8 [Page] buttons [Page Up][Page Down]	These buttons can be used to page up and down when projecting an image from a computer that is connected to the projector through the network. These buttons can be used to switch the screen when projecting with PC Free.
9 [Search] button	Changes to the next input source that is connected to the projector and is sending an image.  p.25
10 [S-Video] button	The input source will change to <b>S-Video</b> .
11 [LAN/USB] button	The input source alternates between <b>LAN</b> and <b>USB</b> each time you click.
12 [Volume] buttons (Volume Down) (Volume Up)	(Volume Down) Decreases the volume. (Volume Up) Increases the volume.

By setting the **Mail Notification** function from the projector's Configuration Menu, notification messages will be sent to the preset email addresses when a problem or warning occurs with a projector. This will enable the operator to be notified of problems with projectors even at locations away from the projectors.  [Network Menu - Mail Menu p.72](#)



- Up to a maximum of three notification destinations (Addresses) can be recorded, and notification messages can be sent to all three destinations at once.
- If a projector develops a critical problem and suddenly stops working, it may not be able to send a message notifying an operator of the problem.
- Monitoring is possible if **Standby Mode** is set to **Communication On** from the **Extended** menu of the projector's Configuration Menu, even if the projector is in standby state (when the power is off).  [p.57](#)

## Reading Problem Mail Notification Function

When the **Mail Notification** function is set to **On** and a problem/warning occurs in the projector, the following e-mail is sent.

Subject: EPSON Projector

Line 1: The name of the projector where the problem has occurred

Line 2: The IP address set for the projector where the problem has occurred.

Line 3 and on: Details of the problem

The details of the problem are listed line by line. The following table shows the details that are given in the message for each item. To deal with problems/warnings, see "Reading the Indicators"  [p.80](#)

Message	Cause (Problems/Warnings)
Clean Air Filter	Air Filter Notice

Message	Cause (Problems/Warnings)
Fan related error	Fan Error
High-speed cooling in progress	High Temp Warning
Internal error	Internal Error
Internal temperature error	High Temp Error (Overheating)
Lamp cover is open.	Lamp Cover Open
Lamp out	Lamp Error
Lamp replacement notification	Replace Lamp
Lamp timer failure	Lamp Failure
Low Air Flow	Low Air Flow
Low Air Flow Error	Filter Airflow Error
No-signal	No Signal No Signal is input to the projector. Check the connection status or check that the power for the signal source is turned on.
Power Err. (Ballast)	Power Err. (Ballast)
Sensor error	Sensor Error

A (+) or (-) appears at the start of the message.

(+): A projector problem has occurred

(-): A projector problem has been dealt with

By setting **SNMP** from the projector's configuration menu, notification messages are sent to preset e-mail addresses when a problem or warning occurs with a projector. This is useful when controlling projectors centrally at a point distant from them.  [p.73](#)



- SNMP should be managed by a network administrator or someone who is familiar with the network.
- To use the SNMP function to monitor the projector, you need to install the SNMP manager program on your computer.
- The managing function using SNMP cannot be used via Wireless LAN in Quick Connection Mode.
- Up to two destination IP addresses can be saved.

## Serial Connection

- Connector shape: D-Sub 9-pin (male)
- Projector input port name: RS-232C

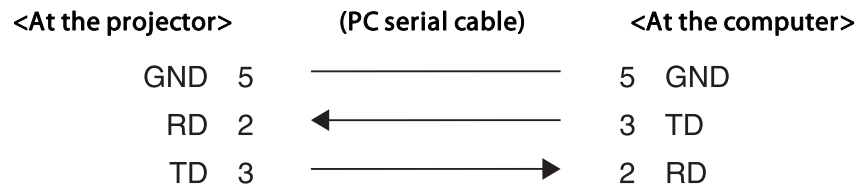
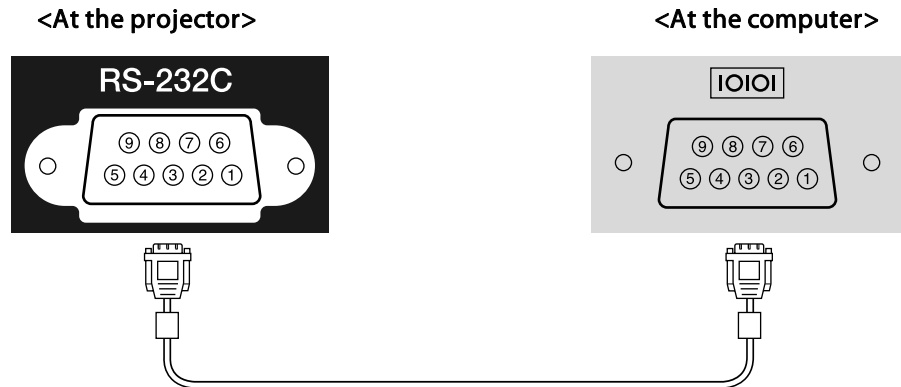

Signal Name	Function
GND	Signal wire ground
TD	Transmit data
RD	Receive data

## Communications protocol

- Default baud rate setting: 9600 bps
- Data length: 8 bit

- Parity: None
- Stop-bit: 1 bit
- Flow control: None

## Command List

When the power ON command is transmitted to the projector, the power turns on and it enters warm-up mode. When the projector's power has turned on, a colon ":" (3Ah) is returned.

When a command is input, the projector executes the command and returns a ":", and then accepts the next command.

If the command being processed terminates abnormally, an error message is output and a ":" is returned.

Item		Command	
Power ON/OFF	On	PWR ON	
	Off	PWR OFF	
Signal selection	Computer1	Auto	SOURCE 1F
		RGB	SOURCE 11
		Component	SOURCE 14
	BNC	Auto	SOURCE BF
		RGB	SOURCE B1
		Component	SOURCE B4
	DVI-D	SOURCE A0	
	HDMI	SOURCE 30	
	Video1	SOURCE 45	
	Video2	SOURCE 41	
S-Video	SOURCE 42		
USB	SOURCE 52		

	Item	Command
	LAN	SOURCE 53
A/V Mute On/Off	On	MUTE ON
	Off	MUTE OFF
A/V Mute selection	Black	MSEL 00
	Blue	MSEL 01
	User's Logo	MSEL 02

Add a Carriage Return (CR) code (0Dh) to the end of each command and transmit.

PJLink Class1 was established by the JBMIA (Japan Business Machine and Information System Industries Association) as a standard protocol for controlling network-compatible projector's as part of their efforts to standardize projector control protocols.

The projector complies with the PJLink Class1 standard established by the JBMIA.

It complies with all commands except for the following commands defined by PJLink Class1, and agreement was confirmed by the PJLink standard adaptability verification.

URL:<http://pjlink.jbmia.or.jp/english/>

- **Non-compatible commands**

Function	PJLink Command
Image muting set	AVMT 11
Audio muting set	AVMT 21

- Input names defined by **PJLink** and corresponding projector sources

Source	PJLink Command
Computer1	INPT 11
BNC	INPT 13
Video1	INPT 23
Video2	INPT 21
S-Video	INPT 22
DVI-D	INPT 31
HDMI	INPT 32
USB	INPT 41
LAN	INPT 52

- Manufacturer name displayed for "Manufacture name information query"  
EPSON

- Model name displayed for "Product name information query"  
EB-G5750WU  
EB-G5450WU

Crestron RoomView® is an integrated control system provided by Crestron®. It can be used to monitor and control multiple devices connected on a network.

The Projector supports the control protocol, and can therefore be used in a system built with Crestron RoomView®.

Refer to the Crestron® website for details on Crestron RoomView®. (Only English-language displays are supported.)

<http://www.crestron.com>

An overview of Crestron RoomView® is provided below.

- **Remote operation using a Web browser**

A Projector can be operated from a computer window just like using a remote control.



- **Monitoring and control with application software**

Crestron RoomView® Express or Crestron RoomView® Server Edition provided by Crestron® can be used to monitor devices in the system, to communicate with the help desk, and to send emergency messages. Refer to the following website for details.

<http://www.crestron.com/getroomview>

This manual describes operating procedures in the computer window using a Web browser.





- Only single-byte alphanumeric characters and symbols can be entered.
- The following functions cannot be used while using the Crestron RoomView®.
  - Web Control  p.105
  - Message Broadcasting (EasyMP Monitor plugin)
- Controlling is possible if **Standby Mode** is set to **Communication On** from the **Extended** menu of the projector's configuration menu, even if the projector is in standby state (when the power is off).
  -  p.57

---

## Operating a Projector from a Computer Window

### Displaying the operation window

Confirm the following before performing the procedure.

- Make sure the computer and projector are connected to the network. When communicating with a wireless LAN, connect in Advanced mode.  p.63
- Set **RoomView** to **On** on the **Others** menu under the **Network** menu. Changes in projector settings take effect upon restarting.  p.73

#### Procedure

1

**Start the Web browser on the computer.**

2

**Enter the IP address of the projector in the address field of the Web browser, and press the [Enter] key on the keyboard.**

The operation window will be displayed.



### Using the operation window

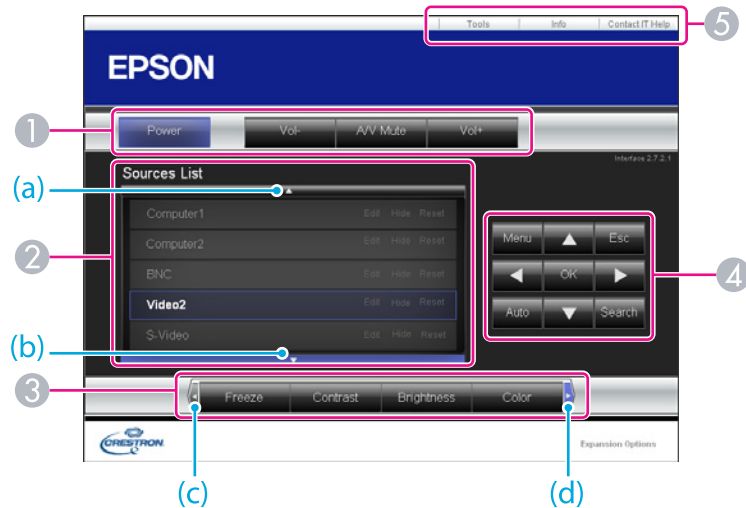



1 The following operations will be performed when the buttons are clicked.



Button	Function
<b>Power</b>	Turns the projector power on or off.
<b>Vol-/Vol+</b>	Adjust the volume.
<b>A/V Mute</b>	Turns the video and audio on or off.  p.34

2 Switch to the image from the selected input source. To display input sources that are not shown in the window, click (a) or (b) to scroll up or down.

3 The following operations will be performed when the buttons are clicked. To display buttons that are not shown in the window, click (c) or (d) to scroll left or right.

Button	Function
<b>Freeze</b>	Images are paused or unpaused.  p.34
<b>Contrast</b>	Adjusts the difference between light and shade in the images.
<b>Brightness</b>	Adjusts the image brightness.
<b>Color</b>	Adjusts the color saturation for the images.
<b>Sharpness</b>	Adjusts the image sharpness.
<b>Zoom</b>	Click the [⊕] button to enlarge the image without changing the projection size. Click the [⊖] button to reduce an image that was enlarged with the [⊕] button. Click the [▲], [▼], [◀], or [▶] button to change the position of an enlarged image.  p.36

4 Clicking the [▲], [▼], [◀], or [▶] button performs the same operation as the [⊕] button on the remote control. The following operations will be performed when the other buttons are clicked.

Button	Function
<b>OK</b>	Performs the same operation as the [Enter] button on the remote control.  p.14
<b>Menu</b>	Displays and closes the configuration menu.
<b>Auto</b>	If clicked when the computer analog RGB signals are being projected, automatically optimizes the image by adjusting the Tracking, Sync., and Zoom Position.
<b>Search</b>	Switches to the image from the input port where video signals are being input.  p.25
<b>Esc</b>	Performs the same operation as the [Esc] button on the remote control.  p.14

5 The following operations will be performed when the tabs are clicked.

Tab	Function
<b>Contact IT Help</b>	Displays the Help Desk window. Used to send and receive messages to the administrator using Crestron RoomView® Express.
<b>Info</b>	Displays information on the projector that is currently connected.
<b>Tools</b>	Changes the settings in the projector that is currently connected. Refer to the next section.

## Using the tools window

The following window will be displayed if the **Tools** tab is clicked in the operation window. This window is used to change the settings in the projector that is currently connected.

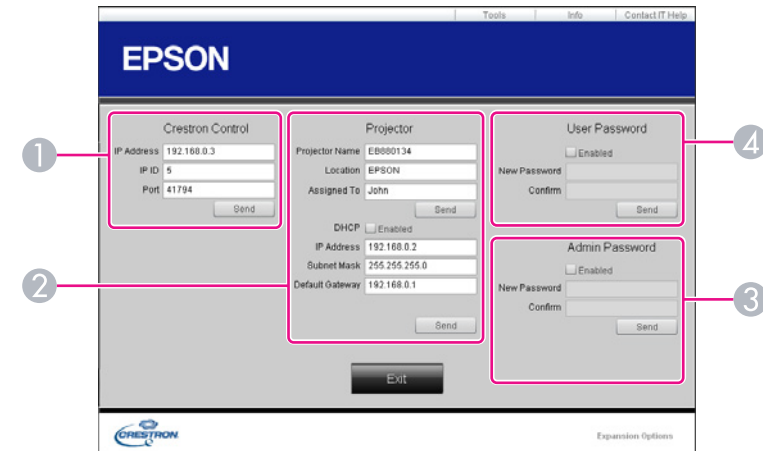

- ① **Crestron Control**  
Makes settings for Crestron® central controllers.
- ② **Projector**  
The following items can be set.
- ③ **Admin Password**  
New Password  
Confirm
- ④ **User Password**  
 Enabled  
New Password  
Confirm

Item	Function
<b>Projector Name</b>	Enter a name to differentiate the projector that is currently connected from other projectors on the network. (The name can contain up to 15 single-byte alphanumeric characters.)
<b>Location</b>	Enter an installation location name for the projector that is currently connected on the network. (The name can contain up to 32 single-byte alphanumeric characters and symbols.)
<b>Assigned To</b>	Enter a user name for the projector. (The name can contain up to 32 single-byte alphanumeric characters and symbols.)

Item	Function
<b>DHCP</b>	Select the <b>Enabled</b> check box to use DHCP. The following address cannot be set if DHCP is enabled.
<b>IP Address</b>	Enter the IP address to assign to the currently connected projector.
<b>Subnet Mask</b>	Enter a subnet mask for the projector that is currently connected on the network.
<b>Default Gateway</b>	Enter the gateway address for the currently connected projector.
<b>Send</b>	Click this button to commit changes made to the <b>Projector</b> .

Item	Function
<b>New Password</b>	Enter the new password when changing the password to open the operation window. (The password can contain up to 26 single-byte alphanumeric characters.)
<b>Confirm</b>	Enter the same password as you entered in <b>New Password</b> . If the passwords are not the same, an error will be displayed.
<b>Send</b>	Click this button to commit changes made to the <b>User Password</b> .

### 3 Admin Password

Select the **Enabled** check box to require a password to open the Tools window. The following items can be set.

Item	Function
<b>New Password</b>	Enter the new password when changing the password to open the Tools window. (The password can contain up to 26 single-byte alphanumeric characters.)
<b>Confirm</b>	Enter the same password as you entered in <b>New Password</b> . If the passwords are not the same, an error will be displayed.
<b>Send</b>	Click this button to commit changes made to the <b>Admin Password</b> .

### 4 User Password

Select the **Enabled** check box to require a password to open the operation window on the computer. The following items can be set.



# Network Functions

This chapter explains the additional functions for networks.

"Connect to a Network Projector" is a standard function in Windows Vista and Windows 7. You can project images from the computer by detecting the projector on the network only by using a function of the OS without having to install any special software.

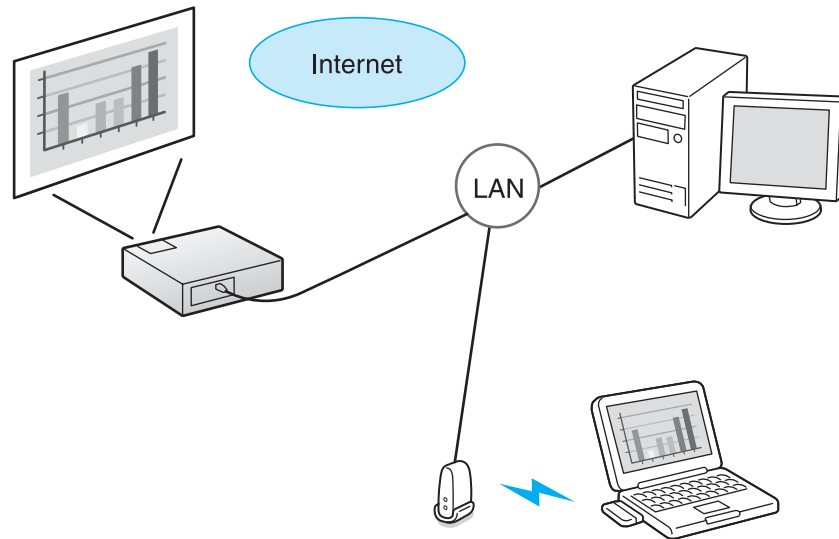

## Compatible OS

Windows Vista:Home Premium/Business/Enterprise/Ultimate  
Windows 7:Professional/Ultimate

This section provides an easy explanation of "Connect to a Network Projector".

Check that the projector and computer are connected to the network, and carry out the following operations.

## Procedure

- 1 Turn the projector on and switch the input source to LAN.  
☛ "Changing the Projected Image" p.25

- 2 On the computer, start Windows, and then click "Start" - "All programs" - "Accessories" - "Connect to a Network Projector".

The connection setting screen is displayed.

The projector is identified by inputting its IP address, or by allowing the OS to automatically identify all of the connected projectors.

- 3 Once the OS has identified all of the connected projectors, select the one that you want to use and click "Connect".

When the projector password screen is displayed, enter the keyword shown at the bottom of the LAN standby screen.



- You can connect only one projector to a computer.
- Audio is not transmitted. When outputting computer audio from the projector, connect the computer's audio output port to the Audio1 input port, Audio2 input port, or Audio3 input port on the projector using a commercially available audio cable. Set the LAN **Audio Input** setting on the **Settings** menu to the port to which the audio cable is connected. ☛ p.55
- When using Network Projector from Options in Windows Meeting Space, set the colors for the computer screen you are using to the highest level (32bit). If it is not capable of a 32bit display, a message is displayed and you cannot connect.

There are two methods for setting WPS».

- Push Button Method

SSID and security are set automatically when the [Enter] button is pressed on the projector's control panel and the dedicated button on the access point equipment. This method is recommended when the projector and access point are close together.

- PIN Code Method

SSID and security are set automatically by inputting an 8-digit code that was assigned to the projector from the computer to the access point in advance. Make connection settings between the computer and the access point in advance. For details on how to make this connection, refer to the manual provided with the access point. This method is recommended when the projector is mounted on the ceiling.



Refer to the documentation for the access point device and to the following section when using any connection method other than WPS.  
☞ "Wireless LAN Menu" p.63

## Connection Setup Method

### Procedure

- 1 During projection, press the [Menu] button and select "Network" - "Network Configuration" from the configuration menu.

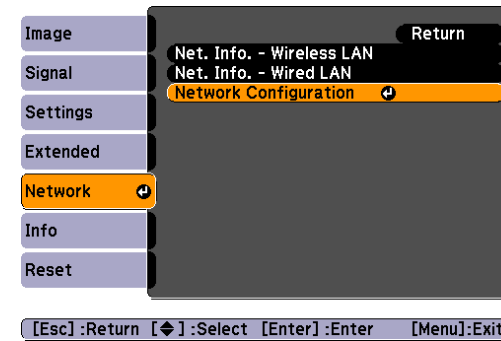

The Network Configuration screen is displayed.



From "Wireless LAN" select "To Setup Wizard".



The following screen is displayed.

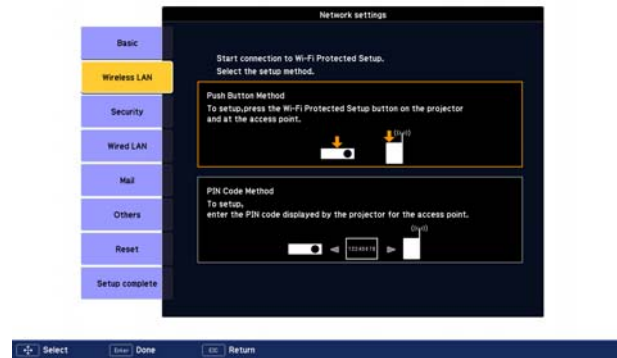

When connecting using the Push Button Method, follow the steps given below.

Go to "Making a connection using the PIN Code Method" when connecting using the "PIN Code Method". [p.120](#)

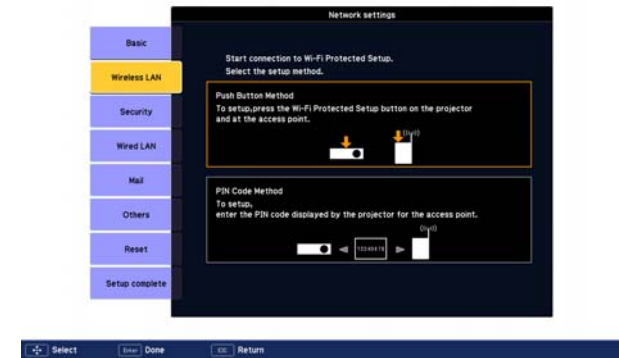

The Push Button Method screen is displayed.

- 2** Press the [Enter] button on the projector's control panel when prompted by the screen.

## Making a connection using the push button method

### Procedure

- 1** Select "Push Button Method".



Then, the Push Button Method screen is displayed.

- 3** Press the button on the access point when prompted by the screen.

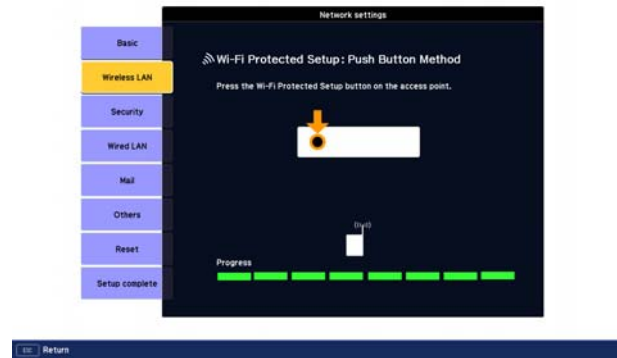

This completes the setup.

- 4 Press the [Enter] button or the [Esc] button.

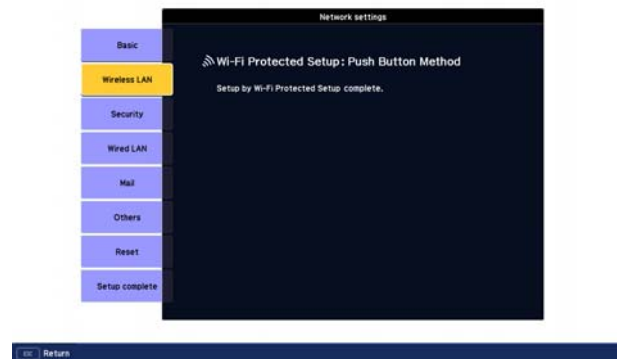

It returns to the Wireless LAN menu screen.

- 5 Select "Setup complete" - "Yes."

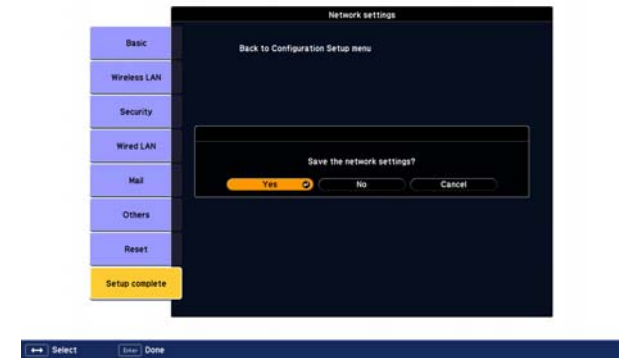

This completes the setup of the connection between the projector and the access point. Press the [Menu] button to close the configuration menu.

## Making a connection using the PIN Code Method



Before you can make a connection using the "PIN Code Method", a connection must have already been setup between the computer and the access point.

### Procedure



- 1 Select "PIN Code Method".



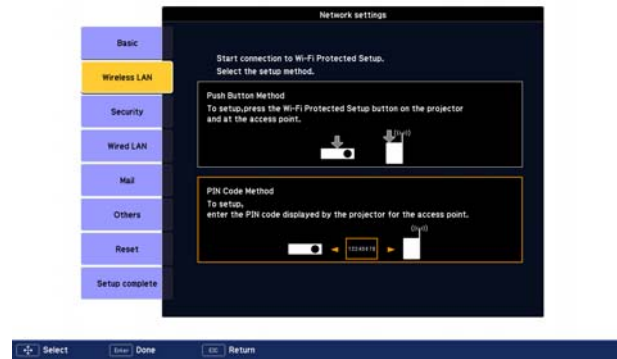

The PIN Code Method screen is displayed.

- 2 Enter the PIN code displayed on the "PIN Code Method" screen from the computer to the access point, and then select "Start Setup".



The progress is displayed.



- 3 The message "Setup by Wi-Fi Protected Setup complete." is displayed. Press the [Enter] button or the [Esc] button.



It returns to the Wireless LAN menu screen.

- 4 Select "Setup complete" - "Yes."



This completes the setup of the connection between the projector and the access point. Press the [Menu] button to close the configuration menu.



# Installation and Connections

This chapter explains the projection installation methods and methods to connect to other equipment.

The projector can be mounted on a ceiling or placed on a desk as shown below.

## Warning

- A special method of installation is required when suspending the projector from a ceiling (ceiling mount). If installation work is not carried out correctly, the projector could fall down. This may result in injury or accidents. Contact your dealer or the nearest address provided in the Support and Service Guide if you want to use this installation method.  [Epson Projector Contact List](#)
- If you use adhesives on the Ceiling mount fixing points to prevent the screws from loosening, or if you use things such as lubricants or oils on the projector, the projector case may crack causing it to fall from its ceiling mount. This could cause serious injury to anyone under the ceiling mount and could damage the projector. When installing or adjusting the ceiling mount, do not use adhesives to prevent the screws from loosening and do not use oils or lubricants and so on.

## Attention

- Do not use the projector on its side. This may cause malfunctions to occur.

- Suspend the projector from the ceiling and project images from in front of a screen. (Front/Ceiling projection)

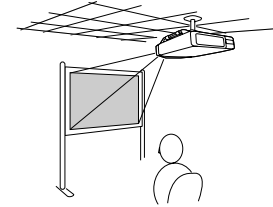

- Suspend the projector from the ceiling and project images from behind a translucent screen. (Rear/Ceiling projection)

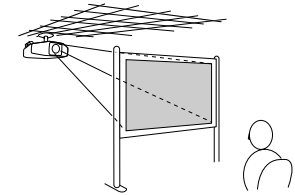

- Project images from in front of the screen. (Front projection)

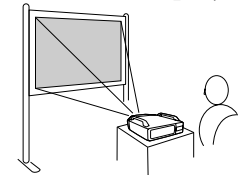

- Project images from behind a translucent screen. (Rear projection)

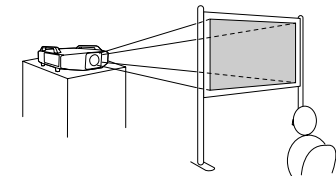

- An optional ceiling mount is required when suspending the projector from a ceiling.  "Optional Accessories and Consumables" p.139

## Switching the Projection Mode

Switch the **Projection** mode according to the installation condition so that a suitable projected image is obtained.

### Procedure

During projection, hold down the [A/V Mute] button on the remote control for about five seconds.

Each time this button is pressed for at least 5 seconds, the **Projection** setting will switch between **Front** and **Front/Ceiling**. The orientation of the projected image will change accordingly.

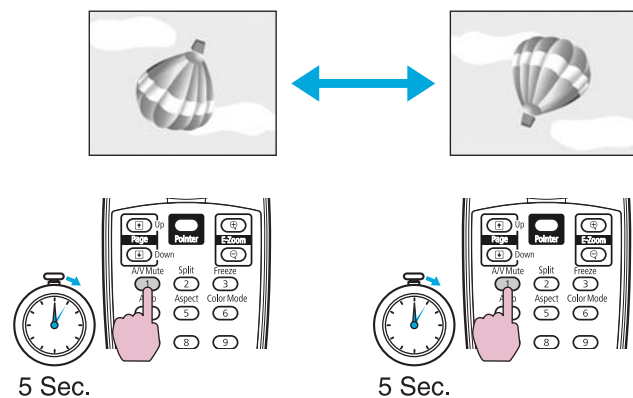

To set **Rear** or **Rear/Ceiling**, use the **Projection** setting on the **Extended** menu. [p.57](#)



When suspending the projector from a ceiling, set the **Inv Direction Button** on the **Extended** menu to **On** so that the [▲], [▼], [◀], and [▶] buttons on the control panel operate in the correct directions. **Extended Menu - Operation - Inv Direction Button**  
[p.57](#)

Observe the following precautions when connecting the projector to external equipment. Be sure to also read the documentation for the external equipment.

### Attention

- Turn off the projector and the external equipment. The projector or external equipment may fail if they are connected while the power is on.
- Check the shapes of the cable connector and port before connecting them. If connecting them is attempted in the wrong direction or when they do not match, failure or equipment damage may occur.

## Connecting to a Computer

This section provides examples of connecting the projector to a computer. The computer port and cable names may also be different from those given.





Refer to the following when projecting images from a computer that is connected through a network.







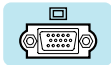
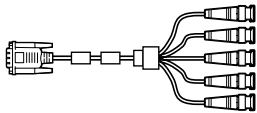
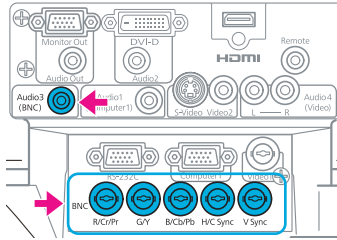

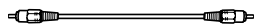
Projecting with the EasyMP Network Projection application software (provided with the projector) ➡ [EasyMP Network Projection Operation Guide](#)

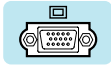
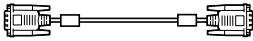
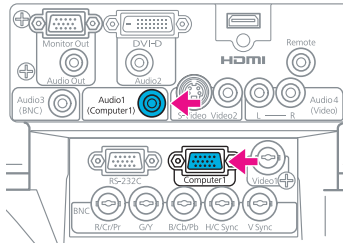
Projecting with the EasyMP Multi PC Projection application software (provided with the projector) ➡ [EasyMP Multi PC Projection Operation Guide](#)

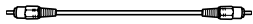
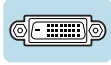
Projecting with the "Connect to a Network Projector" function provided with Windows Vista or Windows 7 ➡ [p.117](#)

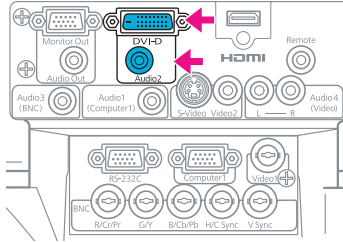
Projecting with Quick Wireless Connection using the optional Quick Wireless Connection USB Key ➡ [User's Guide for the optional product](#)

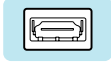
	Computer port	Connecting cable	Projector port
Connection 1	Monitor Out port 	5BNC display cable (commercially available) 	BNC input port Audio3 input port 
	Audio Out port 	Audio cable (commercially available) 	

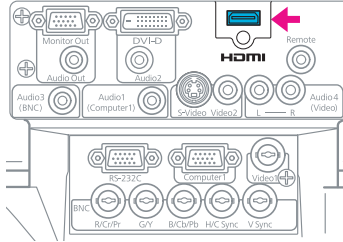
	Computer port	Connecting cable	Projector port
Connection 2	Monitor Out port 	Computer cable (supplied) 	Computer1 input port Audio1 input port 
	Audio Out port 	Audio cable (commercially available) 	
Connection 3	DVI-D output 	DVI-D cable (commercially available) 	DVI-D input port Audio2 input port 
	Audio Out port 	Audio cable (commercially available) 	
Connection 4	HDMI output 	HDMI cable (commercially available) 	HDMI input port 



- Use a cable that complies with the HDMI standard for the HDMI cable.
- A commercially available adapter may be required to connect to a Macintosh computer.

## Changing the video output from a laptop computer.



When projecting images from a laptop computer connected to the projector with a computer cable, the output for the video signal must sometimes be changed at the computer. Refer to the documentation for your computer for the method to change the video output.

- **Example of changing the output (Windows computers)**





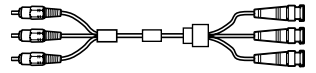
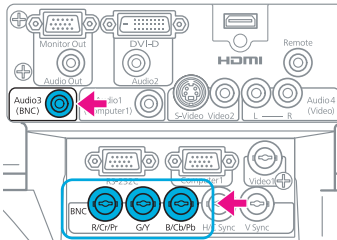
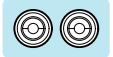
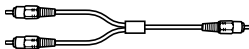

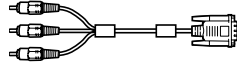
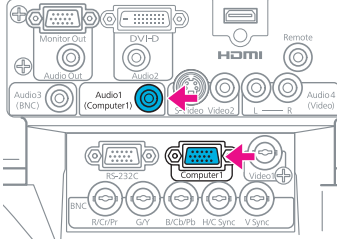

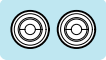
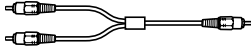

Hold down the [Fn] key on your computer and press the function key labeled CRT/LCD, , and so on. If the image is not displayed on your computer monitor, press the same keys again.

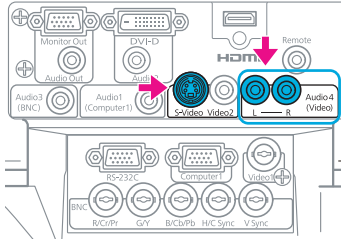

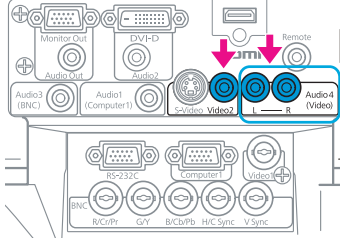

## Connecting to Video Equipment

This section provides examples of connecting the projector to video equipment. The video equipment port and cable names may also be different from those given.

	Port on the video equipment	Connecting cable	Projector port
Connection 1	Component outputs 	RCA component video cable (commercially available) + BNC/RCA adapter (commercially available) 	
	Audio Out port 	Audio cable (commercially available) 	
Connection 2	Component outputs 	Component cable (D-sub/component conversion) (optional accessory) 	

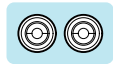

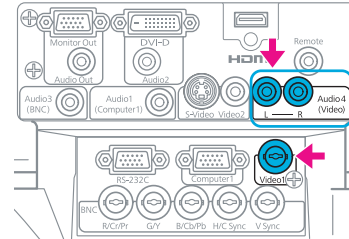
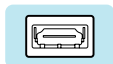
	Port on the video equipment	Connecting cable	Projector port
	Audio Out port 	Audio cable (commercially available) 	
Connection 3	S-Video output 	S-Video cable (commercially available) 	S-Video input port Audio4 input port 
	Audio Out port 	Audio cable (commercially available) 	
Connection 4	Video output 	Video cable (commercially available) 	Video2 input port Audio4 input port 
	Audio Out port 	Audio cable (commercially available) 	
Connection 5	Video output 	BNC video cable (commercially available) 	Video1 input port Audio4 input port

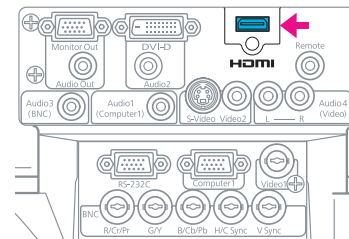
	Port on the video equipment	Connecting cable	Projector port
	Audio Out port 	Audio cable (commercially available) 	
Connection 6	HDMI output 	HDMI cable (commercially available) 	HDMI input port 



- Set the input signal and video signal on the Signal menu according to the signal from the connected equipment.  p.53
- Use a cable that complies with the HDMI standard for the HDMI cable.
- When using a commercially available 2RCA(L/R)/stereo mini-pin audio cable, make sure it is labeled "No resistance".

## Connecting a LAN Cable

Connect with a commercially available 100BASE-TX or 10BASE-T LAN cable.

Connected equipment	Connecting cable	Projector port
LAN port on network hub	LAN cable (commercially available)	LAN port  LAN

### Attention

To prevent malfunctions, use a category 5 shielded LAN cable.

## Connecting to an external monitor

You can display computer images input from a computer on an external monitor connected to the projector and the screen at the same time. This means that you can check projected images on an external monitor when giving presentations even if you cannot see the screen. Connect using the cable supplied with the external monitor.



Only analog RGB signals from a computer connected to the Computer1 input port or the BNC input port can be displayed on an external monitor. Images from equipment connected to other ports and component video signals cannot be displayed.

Connected equipment	Connecting cable	Projector port
Monitor	Cable supplied with monitor	Monitor Out port  Monitor Out



- Setting gauges such as Keystone, the configuration menu, or Help screens are not output to the external monitor.
- The image is not displayed on the external monitor when the projector is on standby.

## Connecting to External Speakers

You can connect speakers with built-in amplifiers to the projector's Audio Out port to enjoy a fuller quality of sound. Connect with a commercially available audio cable (pin plug ↔ 3.5 mm stereo mini plug and so on). Use an audio cable compatible with the connector on the external speakers.

Connected equipment	Connecting cable	Projector port
Audio device	Audio cable (commercially available)	Audio Out port  Audio Out



- When an audio cable plug is inserted in the Audio Out port, the audio changes to the external destination, and audio is no longer emitted from the projector's built-in speaker.
- When using a commercially available 2RCA(L/R)/stereo mini-pin audio cable, make sure it is labeled "No resistance".

## Removing and Attaching the Projector Lens Unit

### Removing

#### Attention

- Only remove the lens unit when necessary. If dust or dirt enter the projector, projection quality deteriorates and it could cause a malfunction.
- Try not to touch the lens section with your hand or fingers. If fingerprints or oils are left on the surface of the lens, projection quality deteriorates.
- If the lens shift has been done, set the lens shift to the center before replacing the lens unit.  [p.20](#)

#### Procedure

- 1 If the lens unit removal button is held in place with a screw, remove the screw.

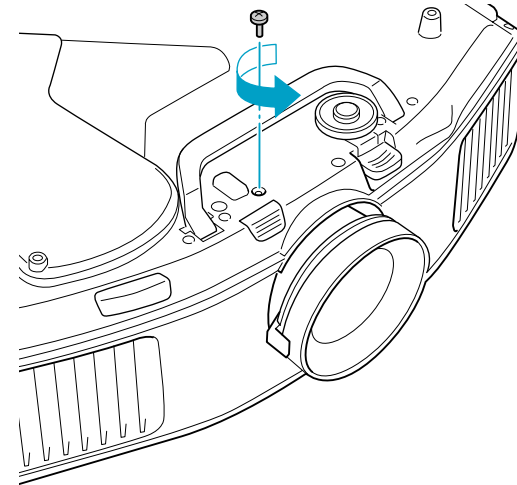

- 2 Hold down the lens unit removal button and turn the lens anti-clockwise until you hear it click.

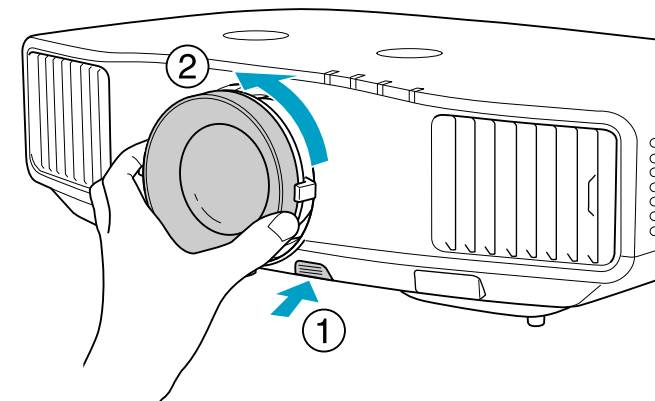

- 3 Pull the lens unit straight out as it is released.

## Attaching

### Attention

Do not attach the lens unit when the projector's lens insertion section is facing up. Dust or dirt could enter the projector.

### Procedure

- 1 Turn clockwise until the focus ring stops moving.

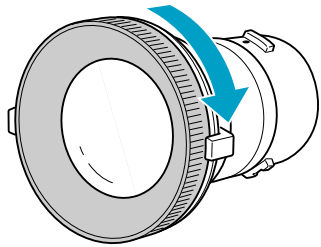

- 2 Insert the lens unit straight into the lens insertion section with the white circle on the lens on top, and then turn clockwise until you hear it click into place.

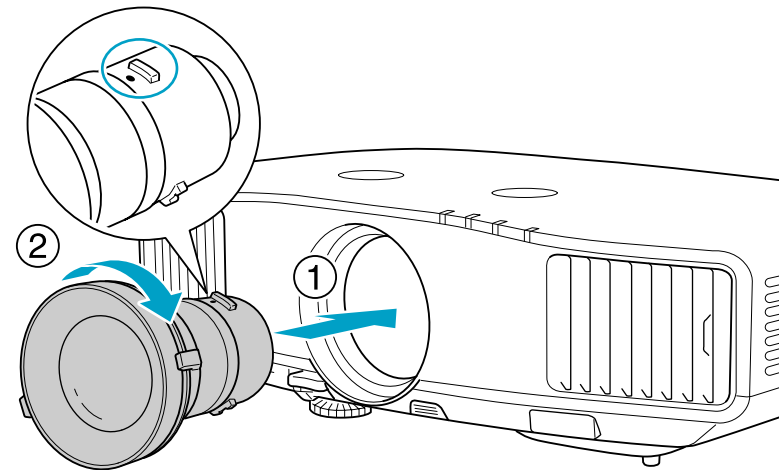

- 3 Check that the lens cannot be detached by turning it anti-clockwise.

### Attention

Store the projector with the lens unit installed.  
If the projector is stored without the lens unit, dust and dirt may get inside the projector and cause malfunctions or lower the quality of projection.

## Installing the Wireless LAN Unit (ELPAP03)

### Attaching

### Procedure

- 1 Remove the cover from the Wireless LAN unit installation section on the projector. Store the cover so that it is not lost.

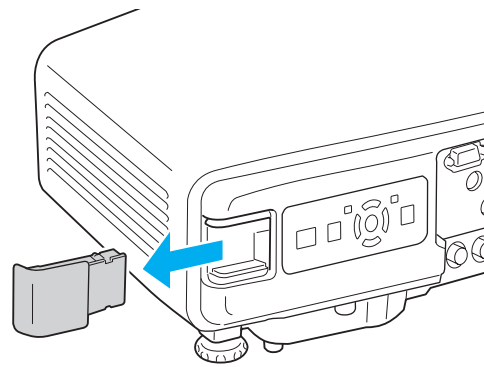

**2** Install the Wireless LAN unit.

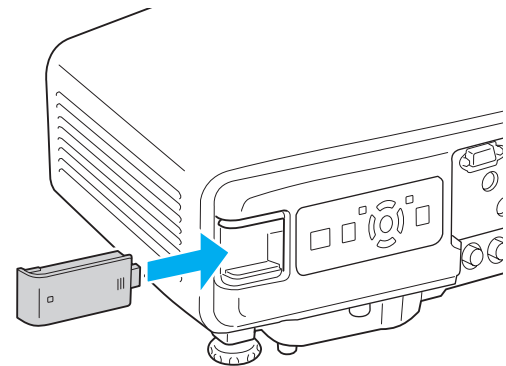

**3** Secure the Wireless LAN unit using the supplied screw to avoid losing the unit.

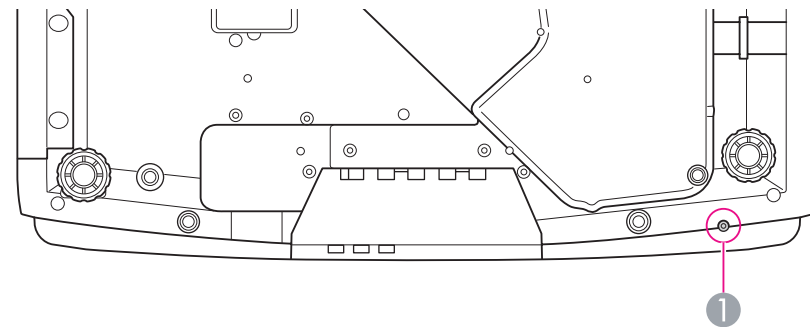

1 Screw hole to fix Wireless LAN unit

When connecting a projector to which the Wireless LAN unit is mounted to a computer using a wireless LAN, set the **Wireless LAN Power** setting on the **Wireless LAN** menu to **On**. (The default setting is **On**.)





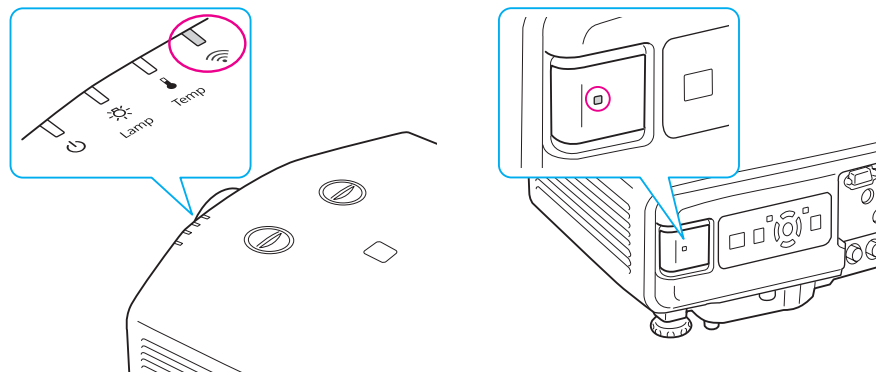

[p.63](#)

### Reading the wireless LAN indicators

There are two Wireless LAN indicators, one on the projector and one on the Wireless LAN unit.



 : Flashing   
  : Lit   
  : Off

Status	Indicator on projector	Indicator on Wireless LAN unit
The Wireless LAN unit not mounted or the <b>Wireless LAN Power</b> setting on the <b>Wireless LAN</b> menu is <b>Off</b>		
The Wireless LAN unit mounted to the projector but not connected to the network		
The Wireless LAN unit mounted to the projector and connected to the network		
The Wireless LAN unit mounted to the projector, connected to the network, and communicating		

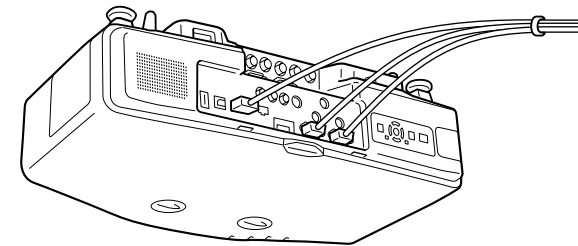

- 2 Insert the tabs on the cable cover into the two holes on the back of the projector.

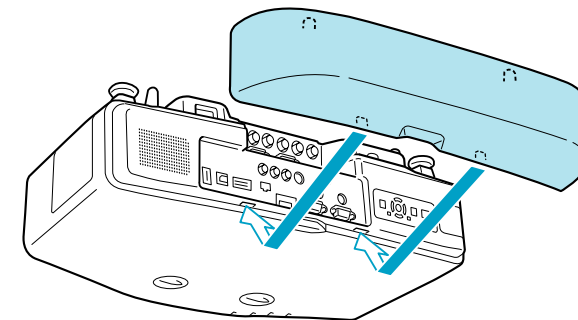

- 3 Tighten the two cable cover screws. (You can tighten the screws with your fingers.)

## Attaching and Removing the Cable Cover

Mounting the cable cover, disordered cables can be tidied away. (The illustration shows a projector suspended from the ceiling.)

### Attaching

#### Procedure

- 1 Bundle the cables with a commercially available band.



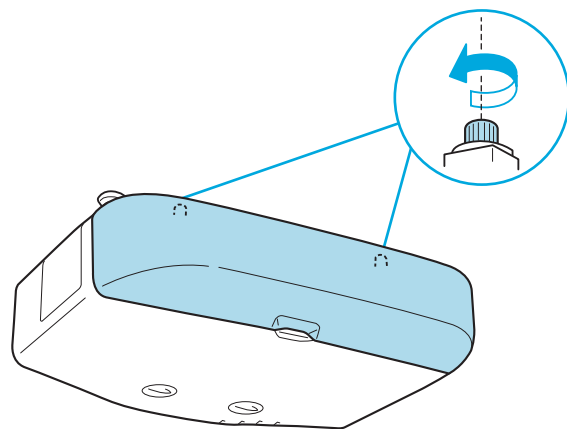

## Removing

### Procedure

Loosen the two cable cover screws and then remove the cable cover.

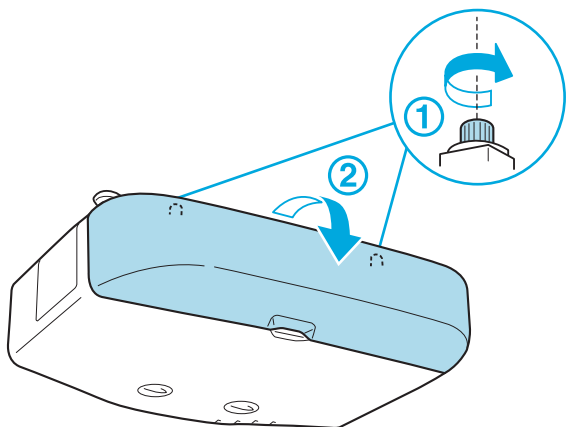



# Appendix

The following optional accessories and consumables are available. Please purchase these products as and when needed. The following list of optional accessories and consumables is current as of: 2010.10. Details of accessories are subject to change without notice and availability may vary depending on the country of purchase.

## Optional accessories

### Computer cable ELPKC02

(1.8 m - for mini D-Sub15-pin/mini D-Sub 15pin)

This is the same as the computer cable supplied with the projector.

### Computer cable ELPKC09

(3 m - for mini D-Sub15-pin/mini D-Sub 15pin)

### Computer cable ELPKC10

(20 m - for mini D-Sub15-pin/mini D-Sub 15pin)

Use one of these longer cables if the computer cable supplied with the projector is too short.

### Component video cable ELPKC19

(3 m - for mini D-Sub 15-pin/RCA male×3)

Use to connect a [Component Video](#) source.

### Remote control cable set ELPKC28

(10 m 2 piece set)

Use this to guarantee operation from the remote control from a distance.

### Wireless mouse receiver ELPST16

Use this to use the projector's remote control to control the mouse pointer on the computer or to page up and down.

### Wireless LAN unit ELPAP03

Use this to project images from a computer via a wireless LAN.

### Quick Wireless Connection USB Key ELPAP08

Use this key to connect to a Windows computer and project images from the computer. However, the projector needs to be connected to a network before it can be used.

### Long focus zoom lens ELPLL06

(Projection distance ratio: Approx. 4.7 to 6.7)

### Medium focus zoom lens ELPLM04

(Projection distance ratio: Approx. 2.2 to 3.4)

### Medium focus zoom lens ELPLM05

(Projection distance ratio: Approx. 3.2 to 5.0)

### Standard focus zoom lens ELPLS05

(Projection distance ratio: Approx. 1.3 to 2.3)

### Wide lens for rear projection ELPLR03

(Projection distance ratio: Approx. 0.77)

Projection distance ratio = projection distance/projection screen width

The values are installation standards. They are subject to change depending on projection conditions.

### Ceiling mount\* ELPMB22

Use when installing the projector on a ceiling.

### Ceiling pipe (450mm)\* ELPFP13

### Ceiling pipe (700mm)\* ELPFP14

Use when installing the projector on a ceiling.

\* A special method of installation is required to suspend the projector from a ceiling. Contact your dealer or the nearest address provided in the Support and Service Guide if you want to use this installation method.  [Epson Projector Contact List](#)



---

### Consumables

**Lamp unit (EB-G5750WU) ELPLP63**

**Lamp unit (EB-G5450WU) ELPLP62**

Use as a replacement for used lamps.

**Air filter ELPAF17**

Use as a replacement for used air filters.

The following table shows the projection distance when a standard lens is attached. When an optional lens is attached, check the projection distances using the Lens Projection Distance Table supplied with this projector. To find the appropriate screen size, see the following table to set up the projector. Values are just reference.

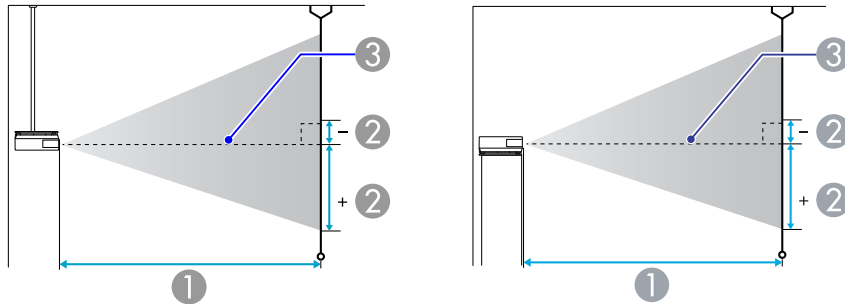

- ① Projection distance
- ② is the distance from the center of the lens to the base of the screen. This changes depending on the setting for vertical lens shift.
- ③ Center of lens

## Projection Distance

Units: cm

4:3 Screen size		①	②
		Minimum (Wide) to Maximum (Tele)	Vertical lens shift Maximum to Minimum
50"	100x76	154 - 279	-6 - +83
60"	120x90	186 - 336	-8 - +99
80"	160x120	250 - 450	-10 - +132
100"	200x150	313 - 563	-13 - +165
120"	240x180	377 - 676	-15 - +198

4:3 Screen size		①	②
		Minimum (Wide) to Maximum (Tele)	Vertical lens shift Maximum to Minimum
150"	300x230	472 - 847	-19 - +248
200"	410x300	631 - 1130	-25 - +330
250"	510x380	790 - 1414	-32 - +413
265"	540x400	838 - 1499	-34 - +438

Units: cm

16:9 Screen size		①	②
		Minimum (Wide) to Maximum (Tele)	Vertical lens shift Maximum to Minimum
50"	110x62	139 - 253	-9 - +72
60"	130x75	168 - 305	-11 - +86
80"	180x100	226 - 408	-15 - +114
100"	220x120	284 - 511	-18 - +143
120"	270x150	342 - 614	-22 - +172
150"	330x190	428 - 768	-28 - +215
200"	440x250	573 - 1026	-37 - +286
250"	550x310	717 - 1283	-46 - +358
290"	640x360	833 - 1489	-54 - +415



Units: cm

16:10 Screen size		①	②
		Minimum (Wide) to Maximum (Tele)	Vertical lens shift Maximum to Minimum
50"	110x67	136 - 246	-6 - +73
60"	130x81	164 - 296	-7 - +88
80"	170x110	220 - 397	-9 - +117
100"	220x130	276 - 497	-11 - +146
120"	260x160	332 - 597	-13 - +175
150"	320x200	417 - 747	-17 - +219
200"	430x270	557 - 998	-22 - +292
250"	540x340	698 - 1248	-28 - +365
300"	640x400	838 - 1499	-34 - +438

## Supported Monitor Displays

### Computer signals (analog RGB)

Signal	Refresh Rate (Hz)	Resolution (dots)
VGA	60/72/75/85	640x480
SVGA	56/60/72/75/85	800x600
XGA	60/70/75/85	1024x768
WXGA	60	1280x768
	60	1360x768
	60/75/85	1280x800
WXGA+	60/75/85	1440x900
WSXGA+*1	60	1680x1050
SXGA	70/75/85	1152x864
	60/75/85	1280x1024
	60/75/85	1280x960
SXGA+	60/75	1400x1050
UXGA	60	1600x1200
WUXGA*2	60	1920x1200
MAC13"	67	640x480
MAC16"	75	832x624
MAC19"	75	1024x768
	59	1024x768
MAC21"	75	1152x870

\*1 Only compatible when Wide is selected as the Resolution from the configuration menu.

\*2 Only compatible when VESA CVT-RB (Reduced Blanking) signal is input. Even when signals other than those mentioned above are input, it is likely that the image can be projected. However, not all functions may be supported.

### Component Video

Signal	Refresh Rate (Hz)	Resolution (dots)
SDTV(480i)	60	720x480
SDTV(576i)	50	720x576
SDTV(480p)	60	720x480
SDTV(576p)	50	720x576
HDTV(720p)	50/60	1280x720
HDTV(1080i)	50/60	1920x1080

### Composite Video/S-Video

Signal	Refresh Rate (Hz)	Resolution (dots)
TV(NTSC)	60	720x480
TV(PAL,SECAM)	50/60	720x576

### Input signals from DVI-D and HDMI input port

Signal	Refresh Rate (Hz)	Resolution (dots)
VGA	60	640x480
SVGA	60	800x600
XGA	60	1024x768
WXGA	60	1280x800
SXGA	60	1280x960
	60	1280x1024
SXGA+	60	1400x1050
UXGA	60	1600x1200
WUXGA*	60	1920x1200



Signal	Refresh Rate (Hz)	Resolution (dots)
SDTV(480i)	60	720x480
SDTV(480p)	60	720x480
SDTV(576i)	50	720x576
SDTV(576p)	50	720x576
HDTV(720p)	50/60	1280x720
HDTV(1080i)	50/60	1920x1080
HDTV(1080p)	24/30/50/60	1920x1080

\* Only compatible when VESA CVT-RB (Reduced Blanking) signal is input.



## Projector General Specifications

<b>Product name</b>		EB-G5750WU	EB-G5450WU
<b>Dimensions</b>		470 (W) × 135 (H) × 311.5 (D) mm (not including foot and projection lens)	
<b>Panel size</b>		0.76" wide	
<b>Display method</b>		Polysilicon TFT active matrix	
<b>Resolution</b>		2,304,000 pixels WUXGA (1920 (W) × 1200 (H) dots) × 3	
<b>Focus adjustment</b>		Manual	
<b>Zoom adjustment*1</b>		Manual (1 to 1.8)	
<b>Lens shift*1</b>		Manual (vertical: approx. 58% max., horizontal: approx. 9% max.)	
<b>Lamp</b>		UHE lamp, 330 W Model No.: ELPLP63	UHE lamp, 275 W Model No.: ELPLP62
<b>Max. audio output</b>		7 W monaural	
<b>Speaker</b>		1	
<b>Power supply</b>		100 to 240 V AC ±10%, 50/60 Hz 4.8 to 2.1A	100 to 240 V AC ±10%, 50/60 Hz 4.2 to 1.8A
<b>Power consumption</b>	<b>100 to 120 V area</b>	Operating: 477 W Standby power consumption (Communication On): 10 W Standby power consumption (Communication Off): 0.38 W	Operating: 413 W Standby power consumption (Communication On): 10 W Standby power consumption (Communication Off): 0.38 W
	<b>220 to 240 V area</b>	Operating: 451 W Standby power consumption (Communication On): 11 W Standby power consumption (Communication Off): 0.47 W	Operating: 393 W Standby power consumption (Communication On): 11 W Standby power consumption (Communication Off): 0.47 W
<b>Operating altitude</b>		Altitude 0 to 3000 m	
<b>Operating temperature</b>		5 to +40°C*2 (No condensation)	
<b>Storage temperature</b>		-10 to +60°C (No condensation)	
<b>Volume*1</b>		Approx. 6.8kg	

\*1 The specifications are when a standard lens is attached. When an optional lens is attached, check the Optional User's Guide supplied with the optional lenses.

\*2 The operating temperature is 0 to +35°C when "Power Consumption" is set to Normal at an altitude of 1500 to 3000m.

Product name			EB-G5750WU	EB-G5450WU
Connectors	Computer1 input port	1	Mini D-Sub15-pin (female) blue	
	Audio1 input port	1	Stereo mini jack	
	DVI-D input port	1	DVI-D 24pin Single Link HDCP compatible	
	Audio2 input port	1	Stereo mini jack	
	BNC input port	1	5BNC (female)	
	Audio3 input port	1	Stereo mini jack	
	Video1 input port	1	1BNC (female)	
	Video2 input port	1	RCA pin jack	
	S-Video input port	1	Mini DIN 4-pin	
	Audio4 input port	1	RCA pin jack × 2 (L, R)	
	HDMI input port	1	HDMI HDCP (Audio is supported only for PCM.)	
	Monitor Out port	1	Mini D-Sub15-pin (female) black	
	Audio Out port	1	Stereo mini jack	
	USB (Type A) port*	1	USB connector (Type A)	
	USB port (Only for Wireless LAN unit)	1	USB connector (Type A)	
	LAN port	1	RJ-45	
	RS-232C port	1	Mini D-Sub 9-pin (male)	
Remote port	1	Stereo mini jack		

\* USB 2.0 is supported. However, the operation of all USB compatible devices is not guaranteed.

This product is also designed for IT power distribution system with phase-to-phase voltage 230V.



Pixelworks DNX™ ICs are used in this projector.

Angle of tilt

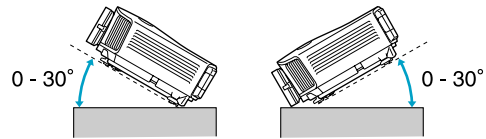

Using the projector at angles not shown in the illustrations above may damage it or cause an accident.

## DECLARATION of CONFORMITY

According to 47CFR, Part 2 and 15  
Class B Personal Computers and Peripherals; and/or  
CPU Boards and Power Supplies used with Class B  
Personal Computers

We: Epson America, Inc.  
Located at: 3840 Kilroy Airport Way  
MS: 3-13  
Long Beach, CA 90806  
Tel: 562-290-5254

Declare under sole responsibility that the product identified herein, complies with 47CFR Part 2 and 15 of the FCC rules as a Class B digital device. Each product marketed, is identical to the representative unit tested and found to be compliant with the standards. Records maintained continue to reflect the equipment being produced can be expected to be within the variation accepted, due to quantity production and testing on a statistical basis as required by 47CFR 2.909. Operation is subject to the following two conditions : (1) this device may not cause harmful interference, and (2) this device must accept any interference received, including interference that may cause undesired operation.

Trade Name: EPSON  
Type of Product: LCD Projector  
Model: H345C/H346C

## FCC Compliance Statement For United States Users

This equipment has been tested and found to comply with the limits for a Class B digital device, pursuant to Part 15 of the FCC Rules. These limits are designed to provide reasonable protection against harmful interference in a residential installation. This equipment generates, uses, and can radiate radio frequency energy and, if not installed and used in accordance with the instructions, may cause harmful interference to radio communications. However, there is no guarantee that interference will not occur in a particular installation. If this equipment does cause harmful interference to radio or television reception, which can be determined by turning the equipment off and on, the user is encouraged to try to correct the interference by one or more of the following measures.

- Reorient or relocate the receiving antenna.
- Increase the separation between the equipment and receiver.
- Connect the equipment into an outlet on a circuit different from that to which the receiver is connected.
- Consult the dealer or an experienced radio/TV technician for help.

### WARNING

The connection of a non-shielded equipment interface cable to this equipment will invalidate the FCC Certification or Declaration of this device and may cause interference levels which exceed the limits established by the FCC for this equipment. It is the responsibility of the user to obtain and use a shielded equipment interface cable with this device. If this equipment has more than one interface connector, do not leave cables connected to unused interfaces. Changes or modifications not expressly approved by the manufacturer could void the user's authority to operate the equipment.

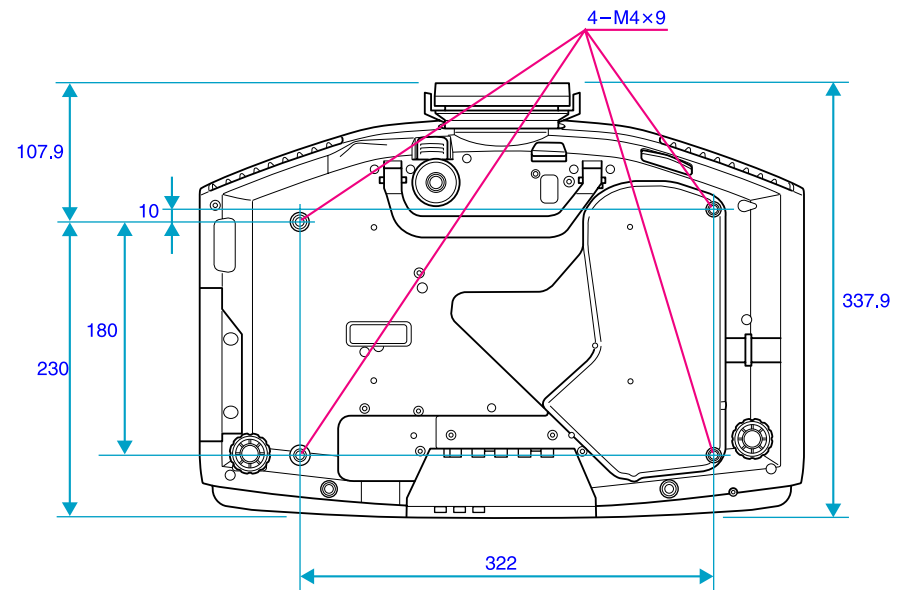
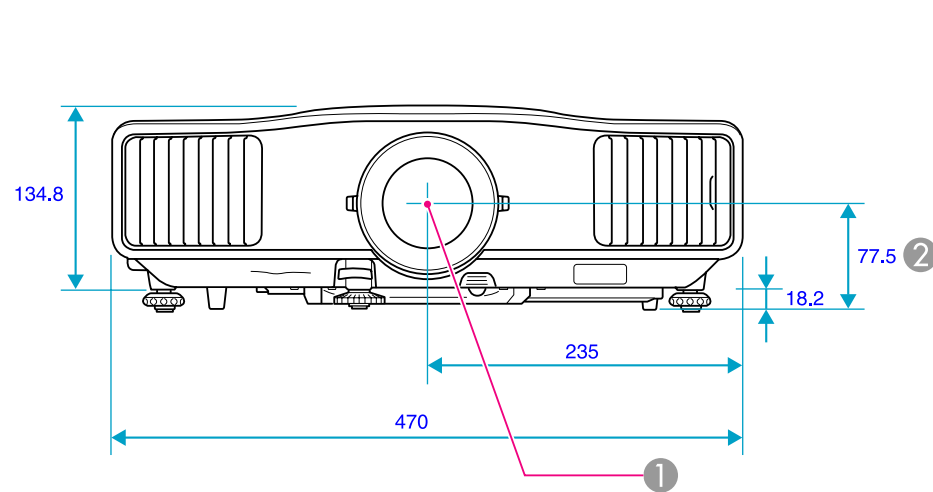



Units: mm

- ① Center of lens
- ② Distance from center of lens to suspension bracket fixing point

This section explains easily terms that are used with the projector and difficult terms that are not explained in the text of this guide. For details, refer to other commercially available publications.

<b>Ad hoc mode</b>	A method of wireless LAN connection that communicates with wireless LAN clients without using an access point. It is not possible to communicate with two or more devices simultaneously.
<b>AMX Device Discovery</b>	AMX Device Discovery is a technology developed by AMX to facilitate AMX control systems for easy operation of the target equipment. Epson have implemented this protocol technology, and have provided a setting to enable the protocol function (ON). See the AMX Web site for more details. URL <a href="http://www.amx.com/">http://www.amx.com/</a>
<b>Aspect Ratio (Aspect Ratio)</b>	The ratio between an image's length and its height. HDTV images have an aspect ratio of 16:9 and appear elongated. The aspect ratio for standard images is 4:3.
<b>Component Video</b>	A Video signal which has the luminance component and color component separated to provide better image quality. Refers to images that consist of three independent signals: Y (luminance signal), Pb and Pr (color difference signals).
<b>Composite video</b>	Video signals that have the video brightness signals and color signals mixed together. The type of signals commonly used by household video equipment (NTSC, PAL, and SECAM formats). The carrier signal Y (luminance signal) and chroma (color) signal that are contained in the color bar are overlapped to form a single signal.
<b>Contrast</b>	The relative brightness of the light and dark areas of an image can be increased or decreased to make text and graphics stand out more clearly, or to make them appear softer. Adjusting this particular property of an image is called Contrast adjustment.
<b>DHCP</b>	An abbreviation of Dynamic Host Configuration Protocol, this protocol automatically assigns an <a href="#">IP Address</a> to equipment connected to a Network.
<b>DICOM</b>	An acronym for Digital Imaging and Communications in Medicine. An international standard that defines image standards and a communications protocol for medical images.
<b>Gateway address (Gateway Address)</b>	This is a server (router) for communicating across a network (subnet) divided according to <a href="#">subnet masks</a> .
<b>HDCP</b>	HDCP is an abbreviation for High-bandwidth Digital Content Protection. It is used to prevent illegal copying and protect copyrights by encrypting digital signals sent over DVI and HDMI input ports. Digital images protected by HDCP technology can be projected with this projector because the projector's HDMI input ports are compatible with HDCP. However, the projector may not be able to project images protected with updated or revised versions of HDCP encryption.
<b>HDTV</b>	An abbreviation for High-Definition Television that refers to high-definition systems which satisfy the following conditions. <ul style="list-style-type: none"> <li>• Vertical resolution of 720p or 1080i or greater (p = <a href="#">Progressive</a>, i = <a href="#">Interlace</a>)</li> <li>• Screen <a href="#">Aspect Ratio</a> of 16:9</li> </ul>
<b>Infrastructure mode</b>	A method for wireless LAN connection in which devices communicate through access points.

<b>Interlace</b>	A method of image scanning whereby the image data is divided into fine horizontal lines that are displayed in sequence starting from left to right and then from top to bottom. The even-numbered lines and odd-numbered lines are displayed alternately.
<b>IP Address</b>	A number to identify a computer connected to a Network.
<b>Progressive</b>	A method of image scanning whereby the image data from a single image is scanned sequentially from top to bottom to create a single image.
<b>Refresh Rate</b>	The light-emitting element of a display maintains the same luminosity and color for an extremely short time. Because of this, the image must be scanned many times per second to refresh the light-emitting element. The number of refresh operations per second is called the Refresh Rate and is expressed in hertz (Hz).
<b>SDTV</b>	An abbreviation for Standard Definition Television that refers to standard television systems which do not satisfy the conditions for <a href="#">HDTV</a>  High-Definition Television.
<b>SNMP</b>	An abbreviation for Simple Network Management Protocol, which is the protocol for monitoring and controlling devices such as routers and computers connected to a TCP/IP Network.
<b>sRGB</b>	An international standard for color intervals that was formulated so that colors that are reproduced by video equipment can be handled easily by computer operating systems (OS) and the Internet. If the connected source has an sRGB mode, set both the projector and the connected signal source to sRGB.
<b>Subnet mask (Subnet Mask)</b>	This is a numerical value that defines the number of bits used for the network address on a divided network (subnet) from the <a href="#">IP Address</a>  .
<b>SVGA</b>	A type of video signal with a resolution of 800 (horizontal) × 600 (vertical) dots that is used by IBM PC/AT-compatible computers.
<b>S-Video</b>	A Video signal which has the luminance component and color component separated to provide better image quality. Refers to images that consist of two independent signals: Y (luminance signal) and C (color signal).
<b>SXGA</b>	A type of video signal with a resolution of 1,280 (horizontal) × 1,024 (vertical) dots that is used by IBM PC/AT-compatible computers.
<b>Sync.</b>	The signals output from computers have a specific frequency. If the projector frequency does not match this frequency, the resulting images are not of a good quality. The process of matching the phases of these signals (the relative position of the crests and the troughs in the signal) is called Synchronization. If the signals are not synchronized, flickering, blurriness, and horizontal interference occur.
<b>Tracking</b>	The signals output from computers have a specific frequency. If the projector frequency does not match this frequency, the resulting images are not of a good quality. The process of matching the frequency of these signals (the number of crests in the signal) is called Tracking. If Tracking is not carried out correctly, wide vertical stripes appear in the signal.
<b>Trap IP Address</b>	This is the <a href="#">IP Address</a>  for the destination computer used for error notification in SNMP.
<b>VGA</b>	A type of video signal with a resolution of 640 (horizontal) × 480 (vertical) dots that is used by IBM PC/AT-compatible computers.
<b>WPS (Wi-Fi Protected Setup)</b>	Wi-Fi Protected Setup has been devised by the Wi-Fi Alliance as a means of easily setting up and securing a Wireless LAN.
<b>XGA</b>	A type of video signal with a resolution of 1,024 (horizontal) × 768 (vertical) dots that is used by IBM PC/AT-compatible computers.

All rights reserved. No part of this publication may be reproduced, stored in a retrieval system, or transmitted in any form or by any means, electronic, mechanical, photocopying, recording, or otherwise, without the prior written permission of Seiko Epson Corporation. No patent liability is assumed with respect to the use of the information contained herein. Neither is any liability assumed for damages resulting from the use of the information contained herein.

Neither Seiko Epson Corporation nor its affiliates shall be liable to the purchaser of this product or third parties for damages, losses, costs, or expenses incurred by the purchaser or third parties as a result of: accident, misuse, or abuse of this product or unauthorized modifications, repairs, or alterations to this product, or (excluding the U.S.) failure to strictly comply with Seiko Epson Corporation's operating and maintenance instructions.

Seiko Epson Corporation shall not be liable against any damages or problems arising from the use of any options or any consumable products other than those designated as Original Epson Products or Epson Approved Products by Seiko Epson Corporation.

The contents of this guide may be changed or updated without further notice.

Illustrations in this guide and the actual projector may differ.

---

## About Notations

Microsoft® Windows® 2000 operating system

Microsoft® Windows® XP Professional operating system

Microsoft® Windows® XP Home Edition operating system

Microsoft® Windows Vista® operating system

Microsoft® Windows® 7 operating system

In this guide, the operating systems above are referred to as "Windows 2000," "Windows XP," "Windows Vista," and "Windows 7". Furthermore, the collective term Windows may be used to refer to Windows 2000, Windows XP, Windows Vista, and Windows 7, and multiple versions of Windows may be referred to as, for example, Windows 2000/XP/Vista, with the Windows notation omitted.

Mac OS X 10.3.x

Mac OS X 10.4.x

Mac OS X 10.5.x

Mac OS X 10.6.x

In this guide, the operating systems above are referred to as "Mac OS X 10.3.9," "Mac OS X 10.4.x," "Mac OS X 10.5.x," and "Mac OS X 10.6.x". Furthermore, the collective term "Mac OS" is used to refer to them.

---

## General Notice

Microsoft, Windows, Windows NT, Windows Vista, Windows 7, PowerPoint, and Windows logo are trademarks or registered trademarks of Microsoft Corporation in the United States and/or other countries.

IBM, DOS/V, and XGA are trademarks or registered trademarks of International Business Machines Corp.

Macintosh, Mac, and iMac are registered trademarks of Apple Inc.

Pixelworks and DNX are trademarks of Pixelworks Inc.

This product includes RSA BSAFE™ software from RSA Security Inc. RSA is a registered trademark of RSA Security Inc. BSAFE RSA Security Inc. is a registered trademark in the United States and other countries.

This product includes **NetNucleus**® **WPA** software from TOSHIBA INFORMATION SYSTEMS CORPORATION.

**NetNucleus** is a registered trademark of TOSHIBA INFORMATION SYSTEMS CORPORATION in Japan.

WPA™, WPA2™ and Wi-Fi Protected Setup™ are registered trademarks of Wi-Fi Alliance.

PJLink trademark is a trademark applied for registration or is already registered in Japan, the United States of America and other countries and areas.

HDMI and High-Definition Multimedia Interface are the trademarks or registered trademarks of HDMI Licensing LLC. 

Other product names used herein are also for identification purposes only and may be trademarks of their respective owners. Epson disclaims any and all rights in those marks.



©SEIKO EPSON CORPORATION 2010. All rights reserved.

#### Software Copyright:

This product uses free software as well as software to which this company holds the rights.

The following is information on the free software used by this product.

1. LGPL
  - (1) This company uses free software for this product under the terms of the GNU LESSER General Public License Version 2, June 1991 (henceforth "LGPL") or later versions.

You can see the full text of the LGPL on the following Web sites.  
[LGPL]<http://www.gnu.org/licenses/gpl.html>

This company, under the terms of the LGPL, discloses the source code for the free software used in this product based on the LGPL.

Contact the support personnel as provided in the Epson Projector Contact list to reproduce, modify, and/or distribute the free software concerned.

Please follow the conditions of the LGPL when reproducing, modifying, and/or distributing the free software concerned.

Also, the free software concerned is offered "as is" with no guarantee or warranty what so ever. The term guarantee includes, but is not limited to, appropriate commercialization, business potential, purpose of use, and does not infringe on third person rights (including, but not limited to, patent rights, copyrights, and trade secrets).
  - (2) Furthermore, as stated in (1), there is no guarantee for free software that is included in this product to which the LGPL applies because of the characteristics of the free software that has already used in this product; any problems in this product (including problems that originate with the free software concerned) do not influence the conditions of the guarantee (written guarantee) issued by this company.
  - (3) Under the terms of the LGPL, the source code as well as authorship for the free software used in this product is disclosed as stated in (1).
2. Other free software

As well as the free software used under the terms of the LGPL, this company also uses the following free software for this product. Hereafter, each author, the conditions, and so on are described in the original. Furthermore, there is no guarantee for free software because of the characteristics of the free software that has already been used in this product; any problems in this product (including problems that originate with the free software concerned) do not influence the conditions of the guarantee (written guarantee) issued by this company.

## (1) libpng

Copyright© 1998-2004 Glenn Randers-Pehrson

Copyright© 1996-1997 Andreas Dilger

Copyright© 1995-1996 Guy Eric Schalnat, Group 42, Inc.

## (2) zlib

Copyright© 1995-2003 Jean-loup Gailly and Mark Adler

**GNU GPL**

This projector product includes the open source software programs which apply the GNU General Public License Version 2 or later version ("GPL Programs").

We provide the source code of the GPL Programs until five (5) years after the discontinuation of same model of this projector product.

If you desire to receive the source code of the GPL Programs, please see the "EPSON Projector Contact List" in the User's Guide, and contact the customer support of your region.

These GPL Programs are WITHOUT ANY WARRANTY; without even the implied warranty of MERCHANTABILITY AND FITNESS FOR A PARTICULAR PURPOSE. See the GNU General Public License for more details.

The list of GPL Programs is as follows and the names of author are described in the source code of the GPL Programs

The list of GPL Programs

**busybox-1.7.2****libgcc1(gcc-4.2.3)****linux-2.6.20****patches****udhcp 0.9.8****uvc rev.219****wireless\_tools 29****Pixelworks PWC950 SDK drivers**

The GNU General Public License Version 2 is as follows. You also can see the GNU General Public License Version 2 at <http://www.gnu.org/licenses/>.

**GNU GENERAL PUBLIC LICENSE**

Version 2, June 1991

Copyright (C) 1989, 1991 Free Software Foundation, Inc., 51 Franklin Street, Fifth Floor, Boston, MA 02110-1301 USA Everyone is permitted to copy and distribute verbatim copies of this license document, but changing it is not allowed.

## Preamble

The licenses for most software are designed to take away your freedom to share and change it. By contrast, the GNU General Public License is intended to guarantee your freedom to share and change free software--to make sure the software is free for all its users. This General Public License applies to most of the Free Software Foundation's software and to any other program whose authors commit to using it. (Some other Free Software Foundation software is covered by the GNU Lesser General Public License instead.) You can apply it to your programs, too.

When we speak of free software, we are referring to freedom, not price. Our General Public Licenses are designed to make sure that you have the freedom to distribute copies of free software (and charge for this service if you wish), that you receive source code or can get it if you want it, that you can change the software or use pieces of it in new free programs; and that you know you can do these things.

To protect your rights, we need to make restrictions that forbid anyone to deny you these rights or to ask you to surrender the rights. These restrictions translate to certain responsibilities for you if you distribute copies of the software, or if you modify it.

For example, if you distribute copies of such a program, whether gratis or for a fee, you must give the recipients all the rights that you have. You must make sure that they, too, receive or can get the source code. And you must show them these terms so they know their rights.

We protect your rights with two steps: (1) copyright the software, and (2) offer you this license which gives you legal permission to copy, distribute and/or modify the software.

Also, for each author's protection and ours, we want to make certain that everyone understands that there is no warranty for this free software. If the software is modified by someone else and passed on, we want its recipients to know that what they have is not the original, so that any problems introduced by others will not reflect on the original authors' reputations.

Finally, any free program is threatened constantly by software patents. We wish to avoid the danger that redistributors of a free program will individually obtain patent licenses, in effect making the program proprietary. To prevent this, we have made it clear that any patent must be licensed for everyone's free use or not licensed at all.

The precise terms and conditions for copying, distribution and modification follow.

#### GNU GENERAL PUBLIC LICENSE TERMS AND CONDITIONS FOR COPYING, DISTRIBUTION AND MODIFICATION

0. This License applies to any program or other work which contains a notice placed by the copyright holder saying it may be distributed under the terms of this General Public License. The "Program", below, refers to any such program or work, and a "work based on the Program" means either the Program or any derivative work under copyright law: that is to say, a work containing the Program or a portion of it, either verbatim or with modifications and/or translated into another language. (Hereinafter, translation is included without limitation in the term "modification".) Each licensee is addressed as "you".

Activities other than copying, distribution and modification are not covered by this License; they are outside its scope. The act of running the Program is not restricted, and the output from the Program is covered only if its contents constitute a work based on the Program (independent of having been made by running the Program). Whether that is true depends on what the Program does.

1. You may copy and distribute verbatim copies of the Program's source code as you receive it, in any medium, provided that you conspicuously and appropriately publish on each copy an appropriate copyright notice and disclaimer of warranty; keep intact all the notices that refer to this License and to the absence of any warranty; and give any other recipients of the Program a copy of this License along with the Program.

You may charge a fee for the physical act of transferring a copy, and you may at your option offer warranty protection in exchange for a fee.

2. You may modify your copy or copies of the Program or any portion of it, thus forming a work based on the Program, and copy and distribute such modifications or work under the terms of Section 1 above, provided that you also meet all of these conditions:
  - a) You must cause the modified files to carry prominent notices stating that you changed the files and the date of any change.
  - b) You must cause any work that you distribute or publish, that in whole or in part contains or is derived from the Program or any part thereof, to be licensed as a whole at no charge to all third parties under the terms of this License.
  - c) If the modified program normally reads commands interactively when run, you must cause it, when started running for such interactive use in the most ordinary way, to print or display an announcement including an appropriate copyright notice and a notice that there is no warranty (or else, saying that you provide a warranty) and that users may redistribute the program under these conditions, and telling the user how to view a copy of this License. (Exception: if the Program itself is interactive but does not normally print such an announcement, your work based on the Program is not required to print an announcement.)

These requirements apply to the modified work as a whole. If identifiable sections of that work are not derived from the Program, and can be reasonably considered independent and separate works in themselves, then this License, and its terms, do not apply to those sections when you distribute them as separate works. But when you distribute the same sections as part of a whole which is a work based on the Program, the distribution of the whole must be on the terms of this License, whose permissions for other licensees extend to the entire whole, and thus to each and every part regardless of who wrote it.

Thus, it is not the intent of this section to claim rights or contest your rights to work written entirely by you; rather, the intent is to exercise the right to control the distribution of derivative or collective works based on the Program.

In addition, mere aggregation of another work not based on the Program with the Program (or with a work based on the Program) on a volume of a storage or distribution medium does not bring the other work under the scope of this License.

3. You may copy and distribute the Program (or a work based on it, under Section 2) in object code or executable form under the terms of Sections 1 and 2 above provided that you also do one of the following:

- a) Accompany it with the complete corresponding machine-readable source code, which must be distributed under the terms of Sections 1 and 2 above on a medium customarily used for software interchange; or,
- b) Accompany it with a written offer, valid for at least three years, to give any third party, for a charge no more than your cost of physically performing source distribution, a complete machine-readable copy of the corresponding source code, to be distributed under the terms of Sections 1 and 2 above on a medium customarily used for software interchange; or,
- c) Accompany it with the information you received as to the offer to distribute corresponding source code. (This alternative is allowed only for noncommercial distribution and only if you received the program in object code or executable form with such an offer, in accord with Subsection b above.)

The source code for a work means the preferred form of the work for making modifications to it. For an executable work, complete source code means all the source code for all modules it contains, plus any associated interface definition files, plus the scripts used to control compilation and installation of the executable. However, as a special exception, the source code distributed need not include anything that is normally distributed (in either source or binary form) with the major components (compiler, kernel, and so on) of the operating system on which the executable runs, unless that component itself accompanies the executable.

If distribution of executable or object code is made by offering access to copy from a designated place, then offering equivalent access to copy the source code from the same place counts as distribution of the source code, even though third parties are not compelled to copy the source along with the object code.

4. You may not copy, modify, sublicense, or distribute the Program except as expressly provided under this License. Any attempt otherwise to copy, modify, sublicense or distribute the Program is void, and will automatically terminate your rights under this License. However, parties who have received copies, or rights, from you under this License will not have their licenses terminated so long as such parties remain in full compliance.
5. You are not required to accept this License, since you have not signed it. However, nothing else grants you permission to modify or distribute the Program or its derivative works. These actions are prohibited by law if you do not accept this License. Therefore, by modifying or distributing the Program (or any work based on the Program), you indicate your acceptance of this License to do so, and all its terms and conditions for copying, distributing or modifying the Program or works based on it.

6. Each time you redistribute the Program (or any work based on the Program), the recipient automatically receives a license from the original licensor to copy, distribute or modify the Program subject to these terms and conditions. You may not impose any further restrictions on the recipients' exercise of the rights granted herein. You are not responsible for enforcing compliance by third parties to this License.
7. If, as a consequence of a court judgment or allegation of patent infringement or for any other reason (not limited to patent issues), conditions are imposed on you (whether by court order, agreement or otherwise) that contradict the conditions of this License, they do not excuse you from the conditions of this License. If you cannot distribute so as to satisfy simultaneously your obligations under this License and any other pertinent obligations, then as a consequence you may not distribute the Program at all. For example, if a patent license would not permit royalty-free redistribution of the Program by all those who receive copies directly or indirectly through you, then the only way you could satisfy both it and this License would be to refrain entirely from distribution of the Program.

If any portion of this section is held invalid or unenforceable under any particular circumstance, the balance of the section is intended to apply and the section as a whole is intended to apply in other circumstances.

It is not the purpose of this section to induce you to infringe any patents or other property right claims or to contest validity of any such claims; this section has the sole purpose of protecting the integrity of the free software distribution system, which is implemented by public license practices. Many people have made generous contributions to the wide range of software distributed through that system in reliance on consistent application of that system; it is up to the author/donor to decide if he or she is willing to distribute software through any other system and a licensee cannot impose that choice.

This section is intended to make thoroughly clear what is believed to be a consequence of the rest of this License.

8. If the distribution and/or use of the Program is restricted in certain countries either by patents or by copyrighted interfaces, the original copyright holder who places the Program under this License may add an explicit geographical distribution limitation excluding those countries, so that distribution is permitted only in or among countries not thus excluded. In such case, this License incorporates the limitation as if written in the body of this License.

9. The Free Software Foundation may publish revised and/or new versions of the General Public License from time to time. Such new versions will be similar in spirit to the present version, but may differ in detail to address new problems or concerns.

Each version is given a distinguishing version number. If the Program specifies a version number of this License which applies to it and "any later version", you have the option of following the terms and conditions either of that version or of any later version published by the Free Software Foundation. If the Program does not specify a version number of this License, you may choose any version ever published by the Free Software Foundation.

10. If you wish to incorporate parts of the Program into other free programs whose distribution conditions are different, write to the author to ask for permission. For software which is copyrighted by the Free Software Foundation, write to the Free Software Foundation; we sometimes make exceptions for this. Our decision will be guided by the two goals of preserving the free status of all derivatives of our free software and of promoting the sharing and reuse of software generally.

#### NO WARRANTY

11. BECAUSE THE PROGRAM IS LICENSED FREE OF CHARGE, THERE IS NO WARRANTY FOR THE PROGRAM, TO THE EXTENT PERMITTED BY APPLICABLE LAW. EXCEPT WHEN OTHERWISE STATED IN WRITING THE COPYRIGHT HOLDERS AND/OR OTHER PARTIES PROVIDE THE PROGRAM "AS IS" WITHOUT WARRANTY OF ANY KIND, EITHER EXPRESSED OR IMPLIED, INCLUDING, BUT NOT LIMITED TO, THE IMPLIED WARRANTIES OF MERCHANTABILITY AND FITNESS FOR A PARTICULAR PURPOSE. THE ENTIRE RISK AS TO THE QUALITY AND PERFORMANCE OF THE PROGRAM IS WITH YOU. SHOULD THE PROGRAM PROVE DEFECTIVE, YOU ASSUME THE COST OF ALL NECESSARY SERVICING, REPAIR OR CORRECTION.

12. IN NO EVENT UNLESS REQUIRED BY APPLICABLE LAW OR AGREED TO IN WRITING WILL ANY COPYRIGHT HOLDER, OR ANY OTHER PARTY WHO MAY MODIFY AND/OR REDISTRIBUTE THE PROGRAM AS PERMITTED ABOVE, BE LIABLE TO YOU FOR DAMAGES, INCLUDING ANY GENERAL, SPECIAL, INCIDENTAL OR CONSEQUENTIAL DAMAGES ARISING OUT OF THE USE OR INABILITY TO USE THE PROGRAM (INCLUDING BUT NOT LIMITED TO LOSS OF DATA OR DATA BEING RENDERED INACCURATE OR LOSSES SUSTAINED BY YOU OR THIRD PARTIES OR A FAILURE OF THE PROGRAM TO OPERATE WITH ANY OTHER PROGRAMS), EVEN IF SUCH HOLDER OR OTHER PARTY HAS BEEN ADVISED OF THE POSSIBILITY OF SUCH DAMAGES.

#### END OF TERMS AND CONDITIONS

##### How to Apply These Terms to Your New Programs

If you develop a new program, and you want it to be of the greatest possible use to the public, the best way to achieve this is to make it free software which everyone can redistribute and change under these terms.

To do so, attach the following notices to the program. It is safest to attach them to the start of each source file to most effectively convey the exclusion of warranty; and each file should have at least the "copyright" line and a pointer to where the full notice is found.

<one line to give the program's name and a brief idea of what it does.>

Copyright (C) <year> <name of author>

This program is free software; you can redistribute it and/or modify it under the terms of the GNU General Public License as published by the Free Software Foundation; either version 2 of the License, or (at your option) any later version.

This program is distributed in the hope that it will be useful, but WITHOUT ANY WARRANTY; without even the implied warranty of MERCHANTABILITY or FITNESS FOR A PARTICULAR PURPOSE. See the GNU General Public License for more details.

You should have received a copy of the GNU General Public License along with this program; if not, write to the Free Software Foundation, Inc., 51 Franklin Street, Fifth Floor, Boston, MA 02110-1301 USA.

Also add information on how to contact you by electronic and paper mail.

If the program is interactive, make it output a short notice like this when it starts in an interactive mode:

Gnomovision version 69, Copyright (C) year name of author Gnomovision comes with ABSOLUTELY NO WARRANTY; for details type `show w'. This is free software, and you are welcome to redistribute it under certain conditions; type `show c' for details.

The hypothetical commands `show w' and `show c' should show the appropriate parts of the General Public License. Of course, the commands you use may be called something other than `show w' and `show c'; they could even be mouse-clicks or menu items--whatever suits your program.

You should also get your employer (if you work as a programmer) or your school, if any, to sign a "copyright disclaimer" for the program, if necessary. Here is a sample; alter the names:

Yoyodyne, Inc., hereby disclaims all copyright interest in the program  
`Gnomovision' (which makes passes at compilers) written by James Hacker.

<signature of Ty Coon>, 1 April 1989

Ty Coon, President of Vice

This General Public License does not permit incorporating your program into proprietary programs. If your program is a subroutine library, you may consider it more useful to permit linking proprietary applications with the library. If this is what you want to do, use the GNU Lesser General Public License instead of this License.

### GNU LGPL

This projector product includes the open source software programs which apply the GNU Lesser General Public License Version 2 or later version ("LGPL Programs").

We provide the source code of the LGPL Programs until five (5) years after the discontinuation of same model of this projector product.

If you desire to receive the source code of the LGPL Programs, please see the "EPSON Projector Contact List" in the User's Guide, and contact the customer support of your region.

These LGPL Programs are WITHOUT ANY WARRANTY; without even the implied warranty of MERCHANTABILITY AND FITNESS FOR A PARTICULAR PURPOSE. See the GNU General Public License for more details.

The list of LGPL Programs is as follows and the names of author are described in the source code of the LGPL Programs.

LGPL Programs

### uClibc-0.9.29

#### SDL-1.2.13

The GNU Lesser General Public License Version 2 is as follows. You also can see the GNU Lesser General Public License Version 2 at <http://www.gnu.org/licenses/>.

### GNU LESSER GENERAL PUBLIC LICENSE

Version 2.1, February 1999

Copyright (C) 1991, 1999 Free Software Foundation, Inc. 51 Franklin Street, Fifth Floor, Boston, MA 02110-1301 USA Everyone is permitted to copy and distribute verbatim copies of this license document, but changing it is not allowed.

[This is the first released version of the Lesser GPL. It also counts as the successor of the GNU Library Public License, version 2, hence the version number 2.1.]

#### Preamble

The licenses for most software are designed to take away your freedom to share and change it. By contrast, the GNU General Public Licenses are intended to guarantee your freedom to share and change free software--to make sure the software is free for all its users.

This license, the Lesser General Public License, applies to some specially designated software packages--typically libraries--of the Free Software Foundation and other authors who decide to use it. You can use it too, but we suggest you first think carefully about whether this license or the ordinary General Public License is the better strategy to use in any particular case, based on the explanations below.

When we speak of free software, we are referring to freedom of use, not price. Our General Public Licenses are designed to make sure that you have the freedom to distribute copies of free software (and charge for this service if you wish); that you receive source code or can get it if you want it; that you can change the software and use pieces of it in new free programs; and that you are informed that you can do these things.

To protect your rights, we need to make restrictions that forbid distributors to deny you these rights or to ask you to surrender these rights. These restrictions translate to certain responsibilities for you if you distribute copies of the library or if you modify it.

For example, if you distribute copies of the library, whether gratis or for a fee, you must give the recipients all the rights that we gave you. You must make sure that they, too, receive or can get the source code. If you link other code with the library, you must provide complete object files to the recipients, so that they can relink them with the library after making changes to the library and recompiling it. And you must show them these terms so they know their rights.

We protect your rights with a two-step method: (1) we copyright the library, and (2) we offer you this license, which gives you legal permission to copy, distribute and/or modify the library.

To protect each distributor, we want to make it very clear that there is no warranty for the free library. Also, if the library is modified by someone else and passed on, the recipients should know that what they have is not the original version, so that the original author's reputation will not be affected by problems that might be introduced by others.

Finally, software patents pose a constant threat to the existence of any free program. We wish to make sure that a company cannot effectively restrict the users of a free program by obtaining a restrictive license from a patent holder. Therefore, we insist that any patent license obtained for a version of the library must be consistent with the full freedom of use specified in this license.

Most GNU software, including some libraries, is covered by the ordinary GNU General Public License. This license, the GNU Lesser General Public License, applies to certain designated libraries, and is quite different from the ordinary General Public License. We use this license for certain libraries in order to permit linking those libraries into non-free programs.

When a program is linked with a library, whether statically or using a shared library, the combination of the two is legally speaking a combined work, a derivative of the original library. The ordinary General Public License therefore permits such linking only if the entire combination fits its criteria of freedom. The Lesser General Public License permits more lax criteria for linking other code with the library.

We call this license the "Lesser" General Public License because it does Less to protect the user's freedom than the ordinary General Public License. It also provides other free software developers Less of an advantage over competing non-free programs. These disadvantages are the reason we use the ordinary General Public License for many libraries. However, the Lesser license provides advantages in certain special circumstances.

For example, on rare occasions, there may be a special need to encourage the widest possible use of a certain library, so that it becomes a de-facto standard. To achieve this, non-free programs must be allowed to use the library. A more frequent case is that a free library does the same job as widely used non-free libraries. In this case, there is little to gain by limiting the free library to free software only, so we use the Lesser General Public License.

In other cases, permission to use a particular library in non-free programs enables a greater number of people to use a large body of free software. For example, permission to use the GNU C Library in non-free programs enables many more people to use the whole GNU operating system, as well as its variant, the GNU/Linux operating system.

Although the Lesser General Public License is Less protective of the users' freedom, it does ensure that the user of a program that is linked with the Library has the freedom and the wherewithal to run that program using a modified version of the Library.

The precise terms and conditions for copying, distribution and modification follow. Pay close attention to the difference between a "work based on the library" and a "work that uses the library". The former contains code derived from the library, whereas the latter must be combined with the library in order to run.

#### **GNU LESSER GENERAL PUBLIC LICENSE TERMS AND CONDITIONS FOR COPYING, DISTRIBUTION AND MODIFICATION**

0. This License Agreement applies to any software library or other program which contains a notice placed by the copyright holder or other authorized party saying it may be distributed under the terms of this Lesser General Public License (also called "this License"). Each licensee is addressed as "you".

A "library" means a collection of software functions and/or data prepared so as to be conveniently linked with application programs (which use some of those functions and data) to form executables.

The "Library", below, refers to any such software library or work which has been distributed under these terms. A "work based on the Library" means either the Library or any derivative work under copyright law: that is to say, a work containing the Library or a portion of it, either verbatim or with modifications and/or translated straightforwardly into another language. (Hereinafter, translation is included without limitation in the term "modification".)

"Source code" for a work means the preferred form of the work for making modifications to it. For a library, complete source code means all the source code for all modules it contains, plus any associated interface definition files, plus the scripts used to control compilation and installation of the library.

Activities other than copying, distribution and modification are not covered by this License; they are outside its scope. The act of running a program using the Library is not restricted, and output from such a program is covered only if its contents constitute a work based on the Library (independent of the use of the Library in a tool for writing it). Whether that is true depends on what the Library does and what the program that uses the Library does.

1. You may copy and distribute verbatim copies of the Library's complete source code as you receive it, in any medium, provided that you conspicuously and appropriately publish on each copy an appropriate copyright notice and disclaimer of warranty; keep intact all the notices that refer to this License and to the absence of any warranty; and distribute a copy of this License along with the Library.

You may charge a fee for the physical act of transferring a copy, and you may at your option offer warranty protection in exchange for a fee.

2. You may modify your copy or copies of the Library or any portion of it, thus forming a work based on the Library, and copy and distribute such modifications or work under the terms of Section 1 above, provided that you also meet all of these conditions:
  - a) The modified work must itself be a software library.
  - b) You must cause the files modified to carry prominent notices stating that you changed the files and the date of any change.
  - c) You must cause the whole of the work to be licensed at no charge to all third parties under the terms of this License.
  - d) If a facility in the modified Library refers to a function or a table of data to be supplied by an application program that uses the facility, other than as an argument passed when the facility is invoked, then you must make a good faith effort to ensure that, in the event an application does not supply such function or table, the facility still operates, and performs whatever part of its purpose remains meaningful.

(For example, a function in a library to compute square roots has a purpose that is entirely well-defined independent of the application. Therefore, Subsection 2d requires that any application-supplied function or table used by this function must be optional: if the application does not supply it, the square root function must still compute square roots.)

These requirements apply to the modified work as a whole. If identifiable sections of that work are not derived from the Library, and can be reasonably considered independent and separate works in themselves, then this License, and its terms, do not apply to those sections when you distribute them as separate works. But when you distribute the same sections as part of a whole which is a work based on the Library, the distribution of the whole must be on the terms of this License, whose permissions for other licensees extend to the entire whole, and thus to each and every part regardless of who wrote it.

Thus, it is not the intent of this section to claim rights or contest your rights to work written entirely by you; rather, the intent is to exercise the right to control the distribution of derivative or collective works based on the Library.

In addition, mere aggregation of another work not based on the Library with the Library (or with a work based on the Library) on a volume of a storage or distribution medium does not bring the other work under the scope of this License.

3. You may opt to apply the terms of the ordinary GNU General Public License instead of this License to a given copy of the Library. To do this, you must alter all the notices that refer to this License, so that they refer to the ordinary GNU General Public License, version 2, instead of to this License. (If a newer version than version 2 of the ordinary GNU General Public License has appeared, then you can specify that version instead if you wish.) Do not make any other change in these notices.

Once this change is made in a given copy, it is irreversible for that copy, so the ordinary GNU General Public License applies to all subsequent copies and derivative works made from that copy.

This option is useful when you wish to copy part of the code of the Library into a program that is not a library.

4. You may copy and distribute the Library (or a portion or derivative of it, under Section 2) in object code or executable form under the terms of Sections 1 and 2 above provided that you accompany it with the complete corresponding machine-readable source code, which must be distributed under the terms of Sections 1 and 2 above on a medium customarily used for software interchange.

If distribution of object code is made by offering access to copy from a designated place, then offering equivalent access to copy the source code from the same place satisfies the requirement to distribute the source code, even though third parties are not compelled to copy the source along with the object code.



5. A program that contains no derivative of any portion of the Library, but is designed to work with the Library by being compiled or linked with it, is called a "work that uses the Library". Such a work, in isolation, is not a derivative work of the Library, and therefore falls outside the scope of this License.

However, linking a "work that uses the Library" with the Library creates an executable that is a derivative of the Library (because it contains portions of the Library), rather than a "work that uses the library". The executable is therefore covered by this License. Section 6 states terms for distribution of such executables.

When a "work that uses the Library" uses material from a header file that is part of the Library, the object code for the work may be a derivative work of the Library even though the source code is not. Whether this is true is especially significant if the work can be linked without the Library, or if the work is itself a library. The threshold for this to be true is not precisely defined by law.

If such an object file uses only numerical parameters, data structure layouts and accessors, and small macros and small inline functions (ten lines or less in length), then the use of the object file is unrestricted, regardless of whether it is legally a derivative work. (Executables containing this object code plus portions of the Library will still fall under Section 6.)

Otherwise, if the work is a derivative of the Library, you may distribute the object code for the work under the terms of Section 6. Any executables containing that work also fall under Section 6, whether or not they are linked directly with the Library itself.

6. As an exception to the Sections above, you may also combine or link a "work that uses the Library" with the Library to produce a work containing portions of the Library, and distribute that work under terms of your choice, provided that the terms permit modification of the work for the customer's own use and reverse engineering for debugging such modifications.

You must give prominent notice with each copy of the work that the Library is used in it and that the Library and its use are covered by this License. You must supply a copy of this License. If the work during execution displays copyright notices, you must include the copyright notice for the Library among them, as well as a reference directing the user to the copy of this License. Also, you must do one of these things:

- a) Accompany the work with the complete corresponding machine-readable source code for the Library including whatever changes were used in the work (which must be distributed under Sections 1 and 2 above); and, if the work is an executable linked with the Library, with the complete machine-readable "work that uses the Library", as object code and/or source code, so that the user can modify the Library and then relink to produce a modified executable containing the modified Library. (It is understood that the user who changes the contents of definitions files in the Library will not necessarily be able to recompile the application to use the modified definitions.)
- b) Use a suitable shared library mechanism for linking with the Library. A suitable mechanism is one that (1) uses at run time a copy of the library already present on the user's computer system, rather than copying library functions into the executable, and (2) will operate properly with a modified version of the library, if the user installs one, as long as the modified version is interface-compatible with the version that the work was made with.
- c) Accompany the work with a written offer, valid for at least three years, to give the same user the materials specified in Subsection 6a, above, for a charge no more than the cost of performing this distribution.
- d) If distribution of the work is made by offering access to copy from a designated place, offer equivalent access to copy the above specified materials from the same place.
- e) Verify that the user has already received a copy of these materials or that you have already sent this user a copy.

For an executable, the required form of the "work that uses the Library" must include any data and utility programs needed for reproducing the executable from it. However, as a special exception, the materials to be distributed need not include anything that is normally distributed (in either source or binary form) with the major components (compiler, kernel, and so on) of the operating system on which the executable runs, unless that component itself accompanies the executable.

It may happen that this requirement contradicts the license restrictions of other proprietary libraries that do not normally accompany the operating system. Such a contradiction means you cannot use both them and the Library together in an executable that you distribute.

7. You may place library facilities that are a work based on the Library side-by-side in a single library together with other library facilities not covered by this License, and distribute such a combined library, provided that the separate distribution of the work based on the Library and of the other library facilities is otherwise permitted, and provided that you do these two things:

- a) Accompany the combined library with a copy of the same work based on the Library, uncombined with any other library facilities. This must be distributed under the terms of the Sections above.
  - b) Give prominent notice with the combined library of the fact that part of it is a work based on the Library, and explaining where to find the accompanying uncombined form of the same work.
8. You may not copy, modify, sublicense, link with, or distribute the Library except as expressly provided under this License. Any attempt otherwise to copy, modify, sublicense, link with, or distribute the Library is void, and will automatically terminate your rights under this License. However, parties who have received copies, or rights, from you under this License will not have their licenses terminated so long as such parties remain in full compliance.
  9. You are not required to accept this License, since you have not signed it. However, nothing else grants you permission to modify or distribute the Library or its derivative works. These actions are prohibited by law if you do not accept this License. Therefore, by modifying or distributing the Library (or any work based on the Library), you indicate your acceptance of this License to do so, and all its terms and conditions for copying, distributing or modifying the Library or works based on it.
  10. Each time you redistribute the Library (or any work based on the Library), the recipient automatically receives a license from the original licensor to copy, distribute, link with or modify the Library subject to these terms and conditions. You may not impose any further restrictions on the recipients' exercise of the rights granted herein. You are not responsible for enforcing compliance by third parties with this License.
  11. If, as a consequence of a court judgment or allegation of patent infringement or for any other reason (not limited to patent issues), conditions are imposed on you (whether by court order, agreement or otherwise) that contradict the conditions of this License, they do not excuse you from the conditions of this License. If you cannot distribute so as to satisfy simultaneously your obligations under this License and any other pertinent obligations, then as a consequence you may not distribute the Library at all. For example, if a patent license would not permit royalty-free redistribution of the Library by all those who receive copies directly or indirectly through you, then the only way you could satisfy both it and this License would be to refrain entirely from distribution of the Library.

If any portion of this section is held invalid or unenforceable under any particular circumstance, the balance of the section is intended to apply, and the section as a whole is intended to apply in other circumstances.

It is not the purpose of this section to induce you to infringe any patents or other property right claims or to contest validity of any such claims; this section has the sole purpose of protecting the integrity of the free software distribution system which is implemented by public license practices. Many people have made generous contributions to the wide range of software distributed through that system in reliance on consistent application of that system; it is up to the author/donor to decide if he or she is willing to distribute software through any other system and a licensee cannot impose that choice.

This section is intended to make thoroughly clear what is believed to be a consequence of the rest of this License.

12. If the distribution and/or use of the Library is restricted in certain countries either by patents or by copyrighted interfaces, the original copyright holder who places the Library under this License may add an explicit geographical distribution limitation excluding those countries, so that distribution is permitted only in or among countries not thus excluded. In such case, this License incorporates the limitation as if written in the body of this License.
13. The Free Software Foundation may publish revised and/or new versions of the Lesser General Public License from time to time. Such new versions will be similar in spirit to the present version, but may differ in detail to address new problems or concerns.  
  
Each version is given a distinguishing version number. If the Library specifies a version number of this License which applies to it and "any later version", you have the option of following the terms and conditions either of that version or of any later version published by the Free Software Foundation. If the Library does not specify a license version number, you may choose any version ever published by the Free Software Foundation.
14. If you wish to incorporate parts of the Library into other free programs whose distribution conditions are incompatible with these, write to the author to ask for permission. For software which is copyrighted by the Free Software Foundation, write to the Free Software Foundation; we sometimes make exceptions for this. Our decision will be guided by the two goals of preserving the free status of all derivatives of our free software and of promoting the sharing and reuse of software generally.

### NO WARRANTY

15. BECAUSE THE LIBRARY IS LICENSED FREE OF CHARGE, THERE IS NO WARRANTY FOR THE LIBRARY, TO THE EXTENT PERMITTED BY APPLICABLE LAW. EXCEPT WHEN OTHERWISE STATED IN WRITING THE COPYRIGHT HOLDERS AND/OR OTHER PARTIES PROVIDE THE LIBRARY "AS IS" WITHOUT WARRANTY OF ANY KIND, EITHER EXPRESSED OR IMPLIED, INCLUDING, BUT NOT LIMITED TO, THE IMPLIED WARRANTIES OF MERCHANTABILITY AND FITNESS FOR A PARTICULAR PURPOSE. THE ENTIRE RISK AS TO THE QUALITY AND PERFORMANCE OF THE LIBRARY IS WITH YOU. SHOULD THE LIBRARY PROVE DEFECTIVE, YOU ASSUME THE COST OF ALL NECESSARY SERVICING, REPAIR OR CORRECTION.
16. IN NO EVENT UNLESS REQUIRED BY APPLICABLE LAW OR AGREED TO IN WRITING WILL ANY COPYRIGHT HOLDER, OR ANY OTHER PARTY WHO MAY MODIFY AND/OR REDISTRIBUTE THE LIBRARY AS PERMITTED ABOVE, BE LIABLE TO YOU FOR DAMAGES, INCLUDING ANY GENERAL, SPECIAL, INCIDENTAL OR CONSEQUENTIAL DAMAGES ARISING OUT OF THE USE OR INABILITY TO USE THE LIBRARY (INCLUDING BUT NOT LIMITED TO LOSS OF DATA OR DATA BEING RENDERED INACCURATE OR LOSSES SUSTAINED BY YOU OR THIRD PARTIES OR A FAILURE OF THE LIBRARY TO OPERATE WITH ANY OTHER SOFTWARE), EVEN IF SUCH HOLDER OR OTHER PARTY HAS BEEN ADVISED OF THE POSSIBILITY OF SUCH DAMAGES.

### END OF TERMS AND CONDITIONS

#### How to Apply These Terms to Your New Libraries

If you develop a new library, and you want it to be of the greatest possible use to the public, we recommend making it free software that everyone can redistribute and change. You can do so by permitting redistribution under these terms (or, alternatively, under the terms of the ordinary General Public License).

To apply these terms, attach the following notices to the library. It is safest to attach them to the start of each source file to most effectively convey the exclusion of warranty; and each file should have at least the "copyright" line and a pointer to where the full notice is found.

<one line to give the library's name and a brief idea of what it does.>

Copyright (C) <year> <name of author>

This library is free software; you can redistribute it and/or modify it under the terms of the GNU Lesser General Public License as published by the Free Software Foundation; either version 2.1 of the License, or (at your option) any later version.

This library is distributed in the hope that it will be useful, but WITHOUT ANY WARRANTY; without even the implied warranty of MERCHANTABILITY or FITNESS FOR A PARTICULAR PURPOSE. See the GNU Lesser General Public License for more details.

You should have received a copy of the GNU Lesser General Public License along with this library; if not, write to the Free Software Foundation, Inc., 51 Franklin Street, Fifth Floor, Boston, MA 02110-1301 USA

Also add information on how to contact you by electronic and paper mail.

You should also get your employer (if you work as a programmer) or your school, if any, to sign a "copyright disclaimer" for the library, if necessary. Here is a sample; alter the names:

Yoyodyne, Inc., hereby disclaims all copyright interest in the library 'Frob' (a library for tweaking knobs) written by James Random Hacker.

<signature of Ty Coon>, 1 April 1990

Ty Coon, President of Vice

That's all there is to it!

### BSD License (Berkeley Software Distribution License)

This projector product includes the open source software program "University of California, Berkeley License (Berkeley Software Distribution License)" which applies the terms and conditions provided by owner of the copyright to the "BSD License".

The "BSD License" are WITHOUT ANY WARRANTY; without even the implied warranty of MERCHANTABILITY AND FITNESS FOR A PARTICULAR PURPOSE.

List of BSD License programs

#### busybox\_1.7.2

License terms of conditions of each program which are provided by owner of the copyright to the "BSD License" are as follows.

Copyright (c) The Regents of the University of California. All rights reserved.

This code is derived from software contributed to Berkeley by Kenneth Almquist.

Redistribution and use in source and binary forms, with or without modification, are permitted provided that the following conditions are met:

1. Redistributions of source code must retain the above copyright notice, this list of conditions and the following disclaimer.
2. Redistributions in binary form must reproduce the above copyright notice, this list of conditions and the following disclaimer in the documentation and/or other materials provided with the distribution.
3. Neither the name of the University nor the names of its contributors may be used to endorse or promote products derived from this software without specific prior written permission.

THIS SOFTWARE IS PROVIDED BY THE REGENTS AND CONTRIBUTORS "AS IS" AND ANY EXPRESS OR IMPLIED WARRANTIES, INCLUDING, BUT NOT LIMITED TO, THE IMPLIED WARRANTIES OF MERCHANTABILITY AND FITNESS FOR A PARTICULAR PURPOSE ARE DISCLAIMED. IN NO EVENT SHALL THE REGENTS OR CONTRIBUTORS BE LIABLE FOR ANY DIRECT, INDIRECT, INCIDENTAL, SPECIAL, EXEMPLARY, OR CONSEQUENTIAL DAMAGES (INCLUDING, BUT NOT LIMITED TO, PROCUREMENT OF SUBSTITUTE GOODS OR SERVICES; LOSS OF USE, DATA, OR PROFITS; OR BUSINESS INTERRUPTION) HOWEVER CAUSED AND ON ANY THEORY OF LIABILITY, WHETHER IN CONTRACT, STRICT LIABILITY, OR TORT (INCLUDING NEGLIGENCE OR OTHERWISE) ARISING IN ANY WAY OUT OF THE USE OF THIS SOFTWARE, EVEN IF ADVISED OF THE POSSIBILITY OF SUCH DAMAGE.

### libjpeg

This projector product includes the open source software program "libjpeg" which applies the terms and conditions provided by owner of the copyright to the "libjpeg".

The "libjpeg" are WITHOUT ANY WARRANTY; without even the implied warranty of MERCHANTABILITY AND FITNESS FOR A PARTICULAR PURPOSE.

List of libjpeg programs

#### libjpeg-6b

License terms of conditions of each program which are provided by owner of the copyright to the "libjpeg" are as follows.

Copyright (C) 1994-1997, Thomas G. Lane. This file is part of the Independent JPEG Group's software. For conditions of distribution and use, see the accompanying README file.

This distribution contains the sixth public release of the Independent JPEG Group's free JPEG software. You are welcome to redistribute this software and to use it for any purpose, subject to the conditions under LEGAL ISSUES, below.

#### LEGAL ISSUES

=====

In plain English:

1. We don't promise that this software works. (But if you find any bugs, please let us know!)
2. You can use this software for whatever you want. You don't have to pay us.
3. You may not pretend that you wrote this software. If you use it in a program, you must acknowledge somewhere in your documentation that you've used the IJG code.

In legalese:

The authors make NO WARRANTY or representation, either express or implied, with respect to this software, its quality, accuracy, merchantability, or fitness for a particular purpose. This software is provided "AS IS", and you, its user, assume the entire risk as to its quality and accuracy.

This software is copyright (C) 1991-1998, Thomas G. Lane. All Rights Reserved except as specified below.

Permission is hereby granted to use, copy, modify, and distribute this software (or portions thereof) for any purpose, without fee, subject to these conditions:

- (1) If any part of the source code for this software is distributed, then this README file must be included, with this copyright and no-warranty notice unaltered; and any additions, deletions, or changes to the original files must be clearly indicated in accompanying documentation.
- (2) If only executable code is distributed, then the accompanying documentation must state that "this software is based in part on the work of the Independent JPEG Group".
- (3) Permission for use of this software is granted only if the user accepts full responsibility for any undesirable consequences; the authors accept NO LIABILITY for damages of any kind.

These conditions apply to any software derived from or based on the IJG code, not just to the unmodified library. If you use our work, you ought to acknowledge us.

Permission is NOT granted for the use of any IJG author's name or company name in advertising or publicity relating to this software or products derived from it. This software may be referred to only as "the Independent JPEG Group's software".

We specifically permit and encourage the use of this software as the basis of commercial products, provided that all warranty or liability claims are assumed by the product vendor.

ansi2knr.c is included in this distribution by permission of L. Peter Deutsch, sole proprietor of its copyright holder, Aladdin Enterprises of Menlo Park, CA. ansi2knr.c is NOT covered by the above copyright and conditions, but instead by the usual distribution terms of the Free Software Foundation; principally, that you must include source code if you redistribute it. (See the file ansi2knr.c for full details.) However, since ansi2knr.c is not needed as part of any program generated from the IJG code, this does not limit you more than the foregoing paragraphs do.

The Unix configuration script "configure" was produced with GNU Autoconf. It is copyright by the Free Software Foundation but is freely distributable. The same holds for its supporting scripts (config.guess, config.sub, ltconfig, ltmain.sh). Another support script, install-sh, is copyright by M.I.T. but is also freely distributable.

It appears that the arithmetic coding option of the JPEG spec is covered by patents owned by IBM, AT&T, and Mitsubishi. Hence arithmetic coding cannot legally be used without obtaining one or more licenses. For this reason, support for arithmetic coding has been removed from the free JPEG software. (Since arithmetic coding provides only a marginal gain over the unpatented Huffman mode, it is unlikely that very many implementations will support it.) So far as we are aware, there are no patent restrictions on the remaining code.

The IJG distribution formerly included code to read and write GIF files. To avoid entanglement with the Unisys LZW patent, GIF reading support has been removed altogether, and the GIF writer has been simplified to produce "uncompressed GIFs". This technique does not use the LZW algorithm; the resulting GIF files are larger than usual, but are readable by all standard GIF decoders.

We are required to state that

"The Graphics Interchange Format(c) is the Copyright property of CompuServe Incorporated. GIF(sm) is a Service Mark property of CompuServe Incorporated."

### libpng

This projector product includes the open source software program "libpng" which applies the terms and conditions provided by owner of the copyright to the "libpng".

The "libpng" are WITHOUT ANY WARRANTY; without even the implied warranty of MERCHANTABILITY AND FITNESS FOR A PARTICULAR PURPOSE.

List of libpng programs

### libpng-1.2.7

License terms of conditions of each program which are provided by owner of the copyright to the "libpng" are as follows.

For conditions of distribution and use, see copyright notice in png.h Copyright (c) 1998-2004 Glenn Randers-Pehrson (Version 0.96 Copyright (c) 1996, 1997 Andreas Dilger) (Version 0.88 Copyright (c) 1995, 1996 Guy Eric Schalnat, Group 42, Inc.)

This copy of the libpng notices is provided for your convenience. In case of any discrepancy between this copy and the notices in the file png.h that is included in the libpng distribution, the latter shall prevail.

COPYRIGHT NOTICE, DISCLAIMER, and LICENSE:

If you modify libpng you may insert additional notices immediately following this sentence.

libpng version 1.2.6, September 12, 2004, is Copyright (c) 2004 Glenn Randers-Pehrson, and is distributed according to the same disclaimer and license as libpng-1.2.5 with the following individual added to the list of Contributing Authors

Cosmin Truta

libpng versions 1.0.7, July 1, 2000, through 1.2.5 - October 3, 2002, are Copyright (c) 2000-2002 Glenn Randers-Pehrson, and are distributed according to the same disclaimer and license as libpng-1.0.6 with the following individuals added to the list of Contributing Authors

Simon-Pierre Cadieux

Eric S. Raymond

Gilles Vollant

and with the following additions to the disclaimer:

There is no warranty against interference with your enjoyment of the library or against infringement. There is no warranty that our efforts or the library will fulfill any of your particular purposes or needs. This library is provided with all faults, and the entire risk of satisfactory quality, performance, accuracy, and effort is with the user.

libpng versions 0.97, January 1998, through 1.0.6, March 20, 2000, are Copyright (c) 1998, 1999 Glenn Randers-Pehrson, and are distributed according to the same disclaimer and license as libpng-0.96, with the following individuals added to the list of Contributing Authors:

Tom Lane  
Glenn Randers-Pehrson  
Willem van Schaik

libpng versions 0.89, June 1996, through 0.96, May 1997, are Copyright (c) 1996, 1997 Andreas Dilger Distributed according to the same disclaimer and license as libpng-0.88, with the following individuals added to the list of Contributing Authors:

John Bowler  
Kevin BraceySam Bushell  
Sam Bushell  
Magnus Holmgren  
Greg Roelofs  
Tom Tanner

libpng versions 0.5, May 1995, through 0.88, January 1996, are Copyright (c) 1995, 1996 Guy Eric Schalnat, Group 42, Inc.

For the purposes of this copyright and license, "Contributing Authors" is defined as the following set of individuals:

Andreas Dilger  
Dave Martindale  
Guy Eric Schalnat  
Paul Schmidt  
Tim Wegner

The PNG Reference Library is supplied "AS IS". The Contributing Authors and Group 42, Inc. disclaim all warranties, expressed or implied, including, without limitation, the warranties of merchantability and of fitness for any purpose. The Contributing Authors and Group 42, Inc. assume no liability for direct, indirect, incidental, special, exemplary, or consequential damages, which may result from the use of the PNG Reference Library, even if advised of the possibility of such damage.

Permission is hereby granted to use, copy, modify, and distribute this source code, or portions hereof, for any purpose, without fee, subject to the following restrictions:

1. The origin of this source code must not be misrepresented.
2. Altered versions must be plainly marked as such and must not be misrepresented as being the original source.
3. This Copyright notice may not be removed or altered from any source or altered source distribution.

The Contributing Authors and Group 42, Inc. specifically permit, without fee, and encourage the use of this source code as a component to supporting the PNG file format in commercial products. If you use this source code in a product, acknowledgment is not required but would be appreciated.

A "png\_get\_copyright" function is available, for convenient use in "about" boxes and the like:

```
printf("%s",png_get_copyright(NULL));
```

Also, the PNG logo (in PNG format, of course) is supplied in the files "pngbar.png" and "pngbar.jpg (88x31) and "pngnow.png" (98x31).

Libpng is OSI Certified Open Source Software. OSI Certified Open Source is a certification mark of the Open Source Initiative.

Glenn Randers-Pehrson  
glennrp@users.sourceforge.net  
September 12, 2004

## zlib

This projector product includes the open source software program "zlib" which applies the terms and conditions provided by owner of the copyright to the "zlib".

The "zlib" are WITHOUT ANY WARRANTY; without even the implied warranty of MERCHANTABILITY AND FITNESS FOR A PARTICULAR PURPOSE.

List of zlib programs

### zlib-1.1.4

License terms of conditions of each program which are provided by owner of the copyright to the "zlib" are as follows.

Copyright notice:

(C) 1995-1998 Jean-loup Gailly and Mark Adler

This software is provided 'as-is', without any express or implied warranty. In no event will the authors be held liable for any damages arising from the use of this software.

Permission is granted to anyone to use this software for any purpose, including commercial applications, and to alter it and redistribute it freely, subject to the following restrictions:

1. The origin of this software must not be misrepresented; you must not claim that you wrote the original software. If you use this software in a product, an acknowledgment in the product documentation would be appreciated but is not required.
2. Altered source versions must be plainly marked as such, and must not be misrepresented as being the original software.
3. This notice may not be removed or altered from any source distribution.

Jean-loup Gailly  
jloup@gzip.org

Mark Adler  
madler@alumni.caltech.edu

If you use the zlib library in a product, we would appreciate \*not\* receiving lengthy legal documents to sign. The sources are provided for free but without warranty of any kind. The library has been entirely written by Jean-loup Gailly and Mark Adler; it does not include third-party code.

If you redistribute modified sources, we would appreciate that you include in the file ChangeLog history information documenting your changes.

### libmd5-rfc

This project product includes the open source software program "libmd5-rfc" which applies the terms and conditions provided by owner of the copyright to the "libmd5-rfc".

The "libmd5-rfc" are WITHOUT ANY WARRANTY; without even the implied warranty of MERCHANTABILITY AND FITNESS FOR A PARTICULAR PURPOSE.

List of libmd5-rfc programs

#### libmd5-rfc

License terms of conditions of each program which are provided by owner of the copyright to the "libmd5-rfc" are as follows.

Copyright (C) 1999, 2002 Aladdin Enterprises. All rights reserved.

This software is provided 'as-is', without any express or implied warranty. In no event will the authors be held liable for any damages arising from the use of this software.

Permission is granted to anyone to use this software for any purpose, including commercial applications, and to alter it and redistribute it freely, subject to the following restrictions:

1. The origin of this software must not be misrepresented; you must not claim that you wrote the original software. If you use this software in a product, an acknowledgment in the product documentation would be appreciated but is not required.
2. Altered source versions must be plainly marked as such, and must not be misrepresented as being the original software.
3. This notice may not be removed or altered from any source distribution.

L. Peter Deutsch ghost@aladdin.com

Independent implementation of MD5 (RFC 1321).

This code implements the MD5 Algorithm defined in RFC 1321, whose text is available at

<http://www.ietf.org/rfc/rfc1321.txt>

The code is derived from the text of the RFC, including the test suite (section A.5) but excluding the rest of Appendix A. It does not include any code or documentation that is identified in the RFC as being copyrighted.

The original and principal author of md5.h is L. Peter Deutsch <ghost@aladdin.com>. Other authors are noted in the change history that follows (in reverse chronological order):

2002-04-13 lpd Removed support for non-ANSI compilers; removed

references to Ghostscript; clarified derivation from RFC 1321; now handles byte order either statically or dynamically.

1999-11-04 lpd Edited comments slightly for automatic TOC extraction.

1999-10-18 lpd Fixed typo in header comment (ansi2knr rather than md5);

added conditionalization for C++ compilation from Martin Purschke <purschke@bnl.gov>.

1999-05-03 lpd Original version.

### ncurses

This project product includes the open source software program "ncurses" which applies the terms and conditions provided by owner of the copyright to the "ncurses".

The "ncurses" are WITHOUT ANY WARRANTY; without even the implied warranty of MERCHANTABILITY AND FITNESS FOR A PARTICULAR PURPOSE.

List of ncurses programs

#### ncurses-5.6

License terms of conditions of each program which are provided by owner of the copyright to the “ncurses” are as follows.

Copyright (c) 1998-2002,2003 Free Software Foundation, Inc.

Permission is hereby granted, free of charge, to any person obtaining a copy of this software and associated documentation files (the "Software"), to deal in the Software without restriction, including without limitation the rights to use, copy, modify, merge, publish, distribute, distribute with modifications, sublicense, and/or sell copies of the Software, and to permit persons to whom the Software is furnished to do so, subject to the following conditions:

The above copyright notice and this permission notice shall be included in all copies or substantial portions of the Software.

THE SOFTWARE IS PROVIDED "AS IS", WITHOUT WARRANTY OF ANY KIND, EXPRESS OR IMPLIED, INCLUDING BUT NOT LIMITED TO THE WARRANTIES OF MERCHANTABILITY, FITNESS FOR A PARTICULAR PURPOSE AND NONINFRINGEMENT. IN NO EVENT SHALL THE ABOVE COPYRIGHT HOLDERS BE LIABLE FOR ANY CLAIM, DAMAGES OR OTHER LIABILITY, WHETHER IN AN ACTION OF CONTRACT, TORT OR OTHERWISE, ARISING FROM, OUT OF OR IN CONNECTION WITH THE SOFTWARE OR THE USE OR OTHER DEALINGS IN THE SOFTWARE.

Except as contained in this notice, the name(s) of the above copyright holders shall not be used in advertising or otherwise to promote the sale, use or other dealings in this Software without prior written authorization.

### **For embedded multimedia software:**

This product contains embedded multimedia software licensed from Ingenient Technologies, Inc. ([www.ingenient.com](http://www.ingenient.com)).

Copyright© 2000-2007 Ingenient Technologies, Inc. All rights reserved.

### **For MPEG-4 ASP:**

With respect to a Licensee offering MPEG-4 Video Decoders and/or Encoders the following notice shall be given: THIS PRODUCT IS LICENSED UNDER THE MPEG-4 VISUAL PATENT PORTFOLIO LICENSE FOR THE PERSONAL AND NON-COMMERCIAL USE OF A CONSUMER FOR (i) ENCODING VIDEO IN COMPLIANCE WITH THE MPEG-4 VISUAL STANDARD ("MPEG-4 VIDEO") AND/OR (ii) DECODING MPEG-4 VIDEO THAT WAS ENCODED BY A CONSUMER ENGAGED IN A PERSONAL AND NON-COMMERCIAL ACTIVITY AND/OR WAS OBTAINED FROM A VIDEO PROVIDER LICENSED BY MPEG LA TO PROVIDE MPEG-4 VIDEO. NO LICENSE IS GRANTED OR SHALL BE IMPLIED FOR ANY OTHER USE. ADDITIONAL INFORMATION INCLUDING THAT RELATING TO PROMOTIONAL, INTERNAL AND COMMERCIAL USES AND LICENSING MAY BE OBTAINED FROM MPEG LA,LLC. SEE [HTTP://WWW.MPEGLA.COM](http://WWW.MPEGLA.COM).

### **For MPEG-4 AVC:**

THIS PRODUCT IS LICENSED UNDER THE AVC PATENT PORTFOLIO LICENSE FOR THE PERSONAL AND NON-COMMERCIAL USE OF A CONSUMER TO (i) ENCODE VIDEO IN COMPLIANCE WITH THE AVC STANDARD ("AVC VIDEO") AND/OR (ii) DECODE AVC VIDEO THAT WAS ENCODED BY A CONSUMER ENGAGED IN A PERSONAL AND NON-COMMERCIAL ACTIVITY AND/OR WAS OBTAINED FROM A VIDEO PROVIDER LICENSED TO PROVIDE AVC VIDEO. NO LICENSE IS GRANTED OR SHALL BE IMPLIED FOR ANY OTHER USE. ADDITIONAL INFORMATION MAY BE OBTAINED FROM MPEG LA, L.L.C. SEE [HTTP://WWW.MPEGLA.COM](http://WWW.MPEGLA.COM)

### **For WMV/WMA (Microsoft):**

This product is protected by certain intellectual property rights of Microsoft. Use or distribution of such technology outside of this product is prohibited without a license from Microsoft.



- Ⓞ indicator ..... 80
- 2**
- 2-2 Pull-down ..... 54
- A**
- A/V Mute ..... 14, 34
- Abs. Color Temp. .... 51
- Air exhaust vent ..... 10
- Air Filter Notice ..... 58
- Air filter replacement period ..... 100
- Air filter tab ..... 10
- AMX Device Discovery ..... 73
- Angle of tilt ..... 147
- Aspect ..... 27, 54
- Audio Out port ..... 12
- Audio1 input port ..... 12
- Audio2 input port ..... 13
- Audio3 input port ..... 12
- Audio4 input port ..... 12
- Auto Setup ..... 53
- B**
- Basic Menu ..... 62
- BNC input port ..... 12
- BNC Sync Termination ..... 58
- Brightness ..... 51
- C**
- Cable cover ..... 136
- Cleaning the Air Filter ..... 94
- Cleaning the Projector's Surface ..... 94
- Color Adjustment ..... 52
- Color Mode ..... 29, 51
- Color Saturation ..... 51
- Computer1 input port ..... 12
- Configuration Menu ..... 50
- Connect to a Network Projector ..... 117
- Consumables ..... 140
- Contrast ..... 51
- Control Panel ..... 13
- Control Panel Lock ..... 47, 55
- Crestron RoomView ..... 112
- Cross ..... 36
- Customized ..... 29
- D**
- DHCP ..... 71
- DICOM SIM ..... 29
- Digital certificate ..... 69
- Direct Power On ..... 58
- Display ..... 57
- Display Background ..... 57
- Distance ..... 141
- DVI/HDMI Video Range ..... 54
- DVI-D input port ..... 13
- Dynamic ..... 29
- E**
- EAP-Fast ..... 70
- EAP-TLS ..... 69
- EAP-TTLS ..... 70
- EasyMP Monitor ..... 104
- ECO ..... 55
- EMail Address 1/2/3 ..... 72
- ESC/VP21 ..... 109
- Event ID ..... 75, 92
- Extended Menu ..... 57
- E-Zoom ..... 36
- F**
- Focus ring ..... 10
- Foot adjust lever ..... 10
- Freeze ..... 34
- Front adjustable foot ..... 10
- Front projection ..... 124
- Front/Ciling projection ..... 124
- Full ..... 27
- Full Lock ..... 47
- G**
- Gateway Address ..... 64, 71
- H**
- H/V-Keystone ..... 23
- HDMI input port ..... 12
- High Altitude Mode ..... 58
- Horizontal lens shift dial ..... 10, 20
- How to replace the air filter ..... 100
- How to replace the lamp ..... 97
- I**
- Image Menu ..... 51
- Indicator ..... 80
- Info Menu ..... 75
- Input Signal ..... 54, 75
- Installation and Connections ..... 123

Inv Direction Button .....	58	Noise Reduction .....	53	Projector Keyword .....	62
IP Address .....	71	Normal .....	55	Projector Name .....	62
<b>K</b>					
Keystone .....	23, 55				
<b>L</b>					
Lamp Hours .....	75				
Lamp indicator .....	80, 97				
Lamp replacement period .....	97				
LAN Audio Input .....	55				
LAN port .....	12				
Language .....	58				
LEAP .....	70				
Lens shift .....	20				
Lens unit removal button .....	10, 11				
<b>M</b>					
MAC Address .....	71				
Mail menu .....	72				
Mail Notification .....	72, 107				
Message Broadcasting .....	104				
Messages .....	57				
Monitor Out port .....	12				
Multi-screen .....	58				
Multi-screen Color Adjustment .....	41				
<b>N</b>					
Native .....	27				
Network Configuration .....	60				
Network Menu .....	60				
Network Protect .....	46				
<b>O</b>					
Operating temperature .....	145				
Operation .....	58				
Optional accessories .....	139				
Others Menu .....	73				
Overheating .....	81				
Overscan .....	54				
<b>P</b>					
Part Names and Functions .....	10				
Partial Lock .....	47				
Password Protect .....	45, 60				
Password protect sticker .....	46				
PEAP .....	70				
Photo .....	29				
PJLink .....	111				
PJLink Password .....	62				
Pointer .....	35				
Pointer Shape .....	55				
Port Number .....	72				
Position .....	53				
Power Consumption .....	55				
Power On Protect .....	45				
Presentation .....	29				
Priority Gateway .....	73				
Problem Solving .....	80				
Progressive .....	53				
Projection .....	57, 124				
Projection lens .....	133				
Projector ID .....	38				
<b>Q</b>					
Quick Corner .....	20, 55				
<b>R</b>					
Rear foot .....	11				
Rear projection .....	124				
Rear/Ceiling projection .....	124				
Refresh Rate .....	75				
Remote Control .....	14				
Remote Control ID .....	39				
Remote port .....	12				
Remote receiver .....	10				
Request Code .....	47				
Reset All .....	76				
Reset Menu .....	74, 76				
Resetting the lamp operating time .....	100				
Resolution .....	75, 143				
RoomView .....	73, 112				
RS-232C port .....	12, 109				
<b>S</b>					
Screen Size .....	31				
Screen size .....	141				
Security Menu .....	65				
Setting a Notification Event .....	72				
Settings Menu .....	55				
Sharpness .....	51				
Signal Menu .....	53				
Sleep Mode .....	58				
SMTP Server .....	72				

Soft kyeboard .....	61
Source .....	75
Source Left .....	31
Source Right .....	31
Source Search .....	13, 15, 25
Specifications .....	145
Split Screen .....	30, 55
Split Screen Setup .....	30
Sports .....	29
sRGB .....	29
Standby Mode .....	58
Startup Screen .....	57
Status indicators .....	10
Storage temperature .....	145
Subnet Mask .....	71
Supported Monitor Displays .....	143
S-Video Input Port .....	12
Swap Screens .....	31
Sync Info .....	75
Sync. ....	53

**T**

Temp indicator .....	80
Temperature indicator .....	94
Test Pattern .....	19, 56
Theatre .....	29
Tint .....	51
Tracking .....	53
Trap IP Address 1/2 .....	73

**U**

USB indicator .....	12
USB(TypeA) port .....	12

User's Logo .....	43
User's Logo Protect .....	45

**V**

Vertical lens shift dial .....	10, 20
Video Signal .....	54, 75
Video1 input port .....	12
Video2 input port .....	12
Volume button .....	15

**W**

Web Control .....	60, 105
Web Control Password .....	62
Web Remote .....	105
WEP .....	66
Wired LAN Menu .....	71
Wireless LAN indicator .....	10, 135
Wireless LAN Menu .....	63
Wireless LAN Power .....	63
Wireless LAN unit .....	134
WPA2-PSK .....	68
WPA-PSK .....	68

**Z**

Zoom .....	27
Zoom ring .....	10